

FDU2602W/FDU2602WT

Unit:mm

Revised

B : Add the housing tolerance for mounting

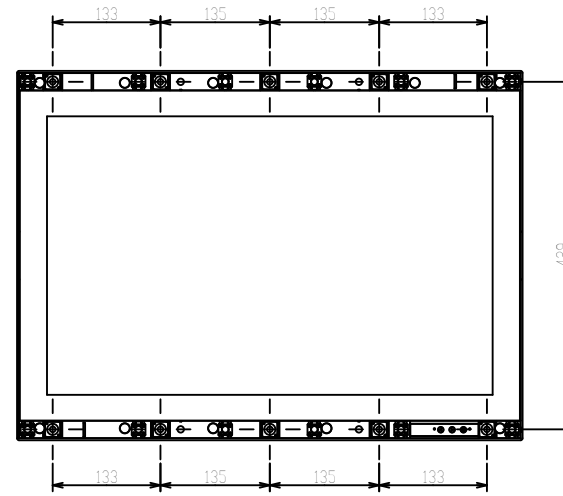
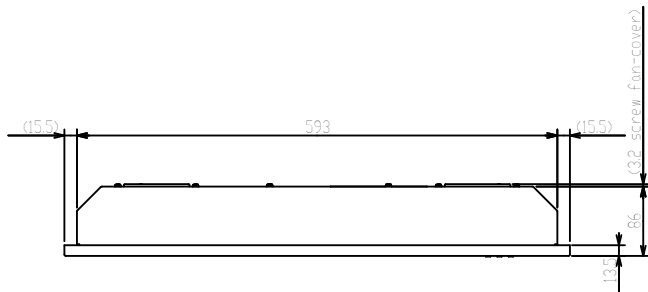

Without design panel
Installation screw position

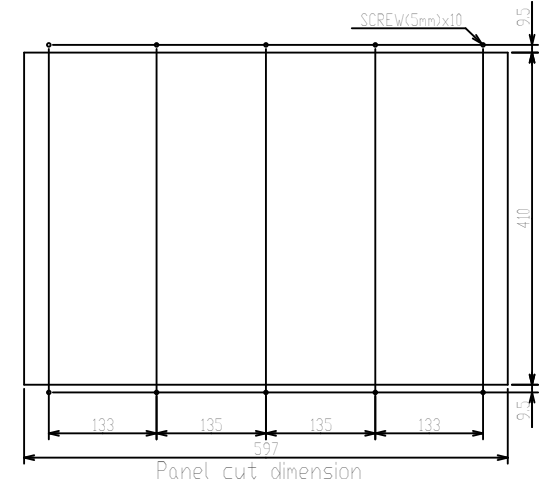

Panel cut dimension

●Housing tolerance for the mounting

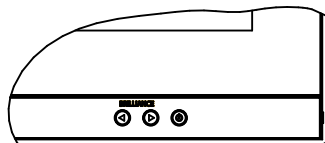
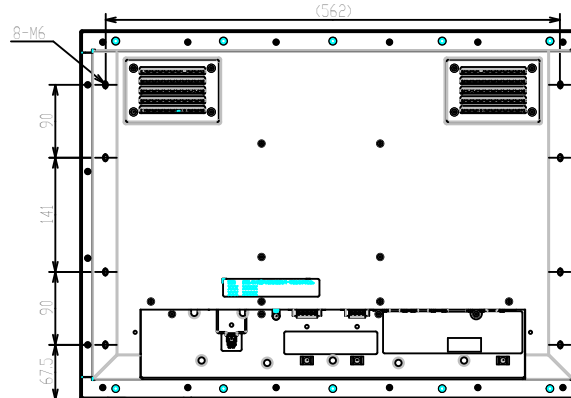
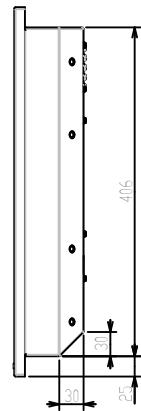
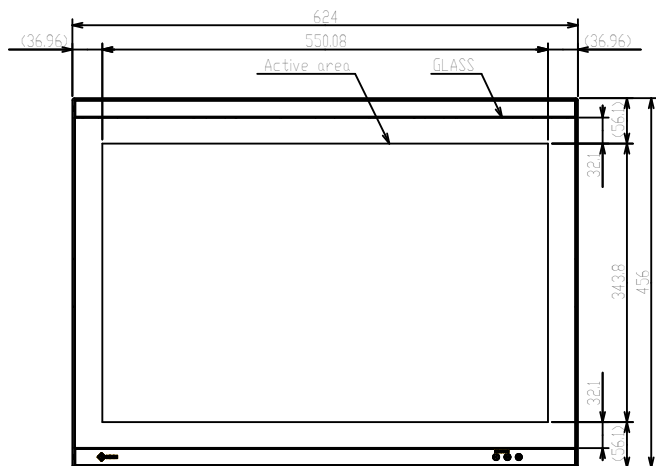
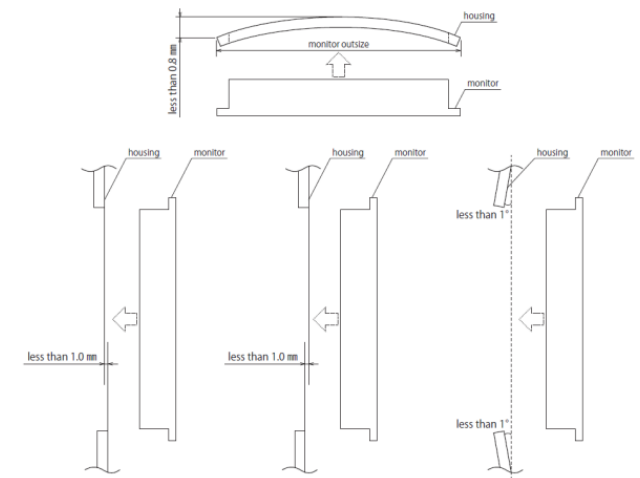

scale 1:2

