



User's Manual

DuraVision® FDX1004T

Touch Panel Color LCD Monitor

Important

Carefully read this User's Manual and Setup Manual before use to use the monitor correctly.

- See the Setup Manual for monitor installation and connection.
- For the latest product information including the "User's Manual", refer to our web site:
www.eizoglobal.com

This product has been adjusted specifically for use in the region to which it was originally shipped.
If operated outside this region, the product may not perform as stated in the specifications.

No part of this manual may be reproduced, stored in a retrieval system, or transmitted, in any form or by any means, electronic, mechanical, or otherwise, without the prior written permission of EIZO Corporation.

EIZO Corporation is under no obligation to hold any submitted material or information confidential unless prior arrangements are made pursuant to EIZO Corporation's receipt of said information. Although every effort has been made to ensure that this manual provides up-to-date information, please note that EIZO product specifications are subject to change without notice.

CONTENTS

1 Introduction	4
1.1 Features	4
2 Basic Adjustment / Settings	5
2.1 Switching the Input Signal	5
2.2 Switching the Display Mode (Color Mode)	5
2.2.1 Display Modes	5
2.3 Adjusting Brightness	5
3 Advanced Adjustment / Setting	6
3.1 Basic Operation of the Setting Menu	6
3.2 Setting Menu Functions	7
3.2.1 Color	7
3.2.2 Signal	9
3.2.3 Preferences	12
3.2.4 Languages	13
3.2.5 Information	13
4 Administrator Settings	14
4.1 Basic Operation of the "Administrator Settings" Menu	14
4.2 Functions of the "Administrator Settings" Menu	15
5 Troubleshooting	17
5.1 No Picture	17
5.2 Imaging Problems (Digital and Analog)	18
5.3 Imaging Problems (Analog only)	19
5.4 Touch Panel Problems	19
5.5 Other Problems	20
6 Reference	21
6.1 Connecting Multiple PCs	21
6.2 Compatible Resolutions	22
Appendix	23
Trademark	23
License	23

1 Introduction

Thank you very much for choosing an EIZO color LCD monitor.

1.1 Features

- 10.4-inch screen
- Supports 1024 x 768 resolution
- The monitor does not have ventilation holes and is designed to be less susceptible to the entry of dust and other particles.
- Wide range of operating temperatures and humidity levels
 - Operating temperature: 0 °C to 50 °C
 - Operating humidity: 20 % to 90 % R.H. (no condensation)
- 2-year long-term warranty with 24-hour continuous use
- Displays HDCP (High Bandwidth Digital Protection) protected content
- Equipped with a touch panel
 - Detection method: Analog-resistive film type
 - Communication method: USB transfer or RS-232C serial transfer (*These cannot be used simultaneously.)

Attention

- In the default settings, RS-232C serial transfer is disabled. To connect a RS-232C cable and use the touch panel, you need to change the settings (see [4.2 Functions of the "Administrator Settings" Menu \[▶ 15\]](#)).

2 Basic Adjustment / Settings

2.1 Switching the Input Signal

When a monitor has multiple signal inputs, the signal to display on-screen can be changed.

1. The input signal switches each time you press **Ⓢ**.
The selected input port name is displayed on the top right of the screen.

2.2 Switching the Display Mode (Color Mode)

This function allows easy selection of a display mode according to monitor application.

1. Press **Ⓜ**.
The Mode menu appears at the bottom left of the screen.
2. Each time **Ⓜ** is pressed, the mode is switched in order and displayed.
You can also switch modes by selecting **⏴** or **⏵** when the Mode menu is displayed.



3. Press **Ⓞ** when you are finished with the settings.

2.2.1 Display Modes

Mode	Purpose
User1 / User2	Select this mode to configure desired settings.
sRGB	Suitable for color matching with sRGB compatible peripherals.

2.3 Adjusting Brightness

Settings: "0" to "100"

The brightness of the screen can be adjusted to suit the installation environment or personal preference.

The screen brightness is adjusted by changing the brightness of the backlight (light source from the LCD back panel).

1. Press **⏴**.
The brightness adjustment screen appears.
2. Specify the setting using **⏴** or **⏵**.
3. Press **Ⓞ** when you are finished with the settings.

3 Advanced Adjustment / Setting

This chapter describes the advanced monitor adjustment and setting procedures using the Setting menu.

For basic functions, see [2 Basic Adjustment / Settings \[▶ 5\]](#).

3.1 Basic Operation of the Setting Menu

1. Press **⊙**.
The Setting menu appears.

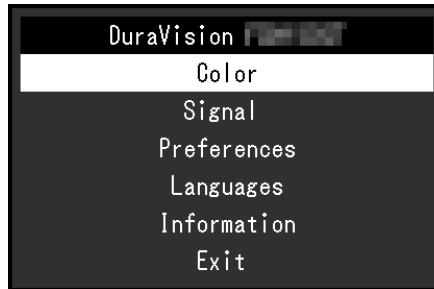

2. Select the menu to adjust/set with **▼▲**, then press **⊙**.
The Sub menu appears.



3. Select the menu to adjust/set with **▼▲**, then press **⊙**.
The Adjustment/Setting menu appears.



4. Perform adjustment/setting with **▼▲**, then press **⊙**.
The Sub menu appears.
5. Select "Return" in the Sub menu, then press **⊙**.
The Setting menu appears.
6. Select "Exit" in the Setting menu, then press **⊙**.
The Setting menu exits.

Note

- Quickly pressing **⊙** twice in a row will also exit the Setting menu.

3.2 Setting Menu Functions

3.2.1 Color

The color mode settings can be adjusted according to personal preference. The adjusted settings are saved for each color mode.



Functions that can be adjusted differ depending on the color mode.

✓: Adjustable, -: Not adjustable

Function	Color Mode	
	User1 User2	sRGB
Brightness	✓	✓
Temperature	✓	-
Gamma	✓	-
Advanced Settings	Hue	✓
	Saturation	✓
	Gain	✓
Reset	✓	✓

Attention

- It takes about 30 minutes for the monitor display to stabilize. Please wait 30 minutes or more after power to the monitor has been turned on before adjusting the monitor.
- The same image may be observed in different colors on multiple monitors due to monitor-specific characteristics. Make fine color adjustments visually when matching colors across multiple monitors. Follow the procedure below to adjust and match colors across multiple monitors.
 1. Display a white screen on each monitor.
 2. Use one of the monitors as a visual reference point to make adjustments to "Brightness", "Temperature", and "Gain" on the other monitors.

Brightness

Settings: "0" to "100"

The screen brightness is adjusted by changing the brightness of the backlight (light source from the LCD back panel).

Temperature

Settings: "Off" / "4000 K" – "10000 K (in increments of 500 K. 9300 K is included.)"

Adjusts the color temperature.

The color temperature is normally used to express the hue of "White" and/or "Black" with a numerical value. The value is expressed in degrees "K" (Kelvin).

The screen becomes reddish at low color temperatures and bluish at high color temperatures, similar to the temperatures of a flame. A gain preset value is set for each color temperature setting value.

Note

- The value shown in "K" is available only as a reference.
- "Gain" allows you to perform more advanced adjustment (see [Advanced Settings - Gain \[▶ 8\]](#)).
- If set to "Off", the image is displayed in the preset color of the LCD panel (Gain: 100 for each RGB channel).
- When the gain is changed, the color temperature setting changes to "Off".

Gamma

Settings: "1.8" / "2.0" / "2.2"

Adjusts the gamma.

While the brightness of the monitor varies depending on the video level of the input signal, the variation rate is not directly proportional to the input signal. Maintaining the balance between the input signal and brightness of the monitor is referred to as "Gamma correction".

Note

- If "sRGB" is selected for the color mode, "sRGB" is displayed for the gamma value.

Advanced Settings - Hue

Settings: "-50" – "50"

Adjusts the hue.

Note

- Using this function may prevent some color gradations from being able to be displayed.

Advanced Settings - Saturation

Settings: "-50" – "50"

Adjusts the color saturation.

Note

- Using this function may prevent some color gradations from being able to be displayed.
- The minimum value (-50) changes the screen to monochrome.

Advanced Settings - Gain

Settings: "0" – "100"

The brightness of each red, green, and blue color component is referred to as "Gain". The hue of "white" can be changed by adjusting the gain.

Note

- Using this function may prevent some color gradations from being able to be displayed.
- The gain value changes according to the color temperature.
- When the gain is changed, the color temperature setting changes to "Off".

Reset

Resets any color adjustments for the currently selected color mode back to the default settings.

3.2.2 Signal

Set the details regarding input signal, such as the screen size and color format.

- D-Sub input

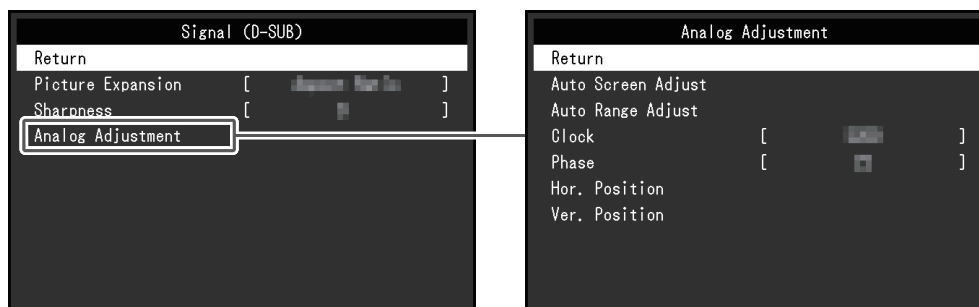

- HDMI® / DisplayPort™ input

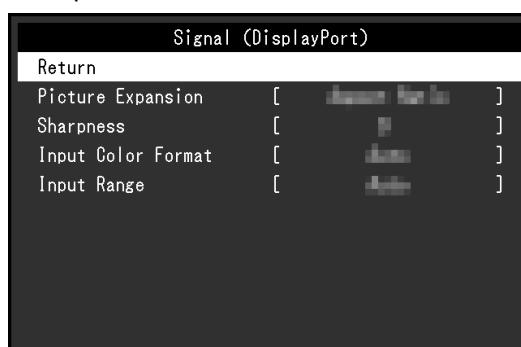

The functions that can be set differ depending on the input signal.

✓: Can be set, -: Cannot be set.

Function	Input Signal		
	DisplayPort	HDMI	D-SUB
Picture Expansion	✓	✓	✓
Sharpness	✓	✓	✓
Input Color Format	✓	✓	-
Input Range	✓	✓	-
Analog Adjustment	-	-	✓

Picture Expansion

Settings: "Auto"^{*1} / "Full Screen" / "Aspect Ratio" / "Dot by Dot"

^{*1} Only enabled during HDMI input



The screen size of the monitor display can be changed.

- "Auto"

The monitor automatically changes the screen size according to the aspect ratio and resolution information from the PC.
- "Full Screen"

Images are stretched to full screen. Since aspect ratios are not maintained, images may be distorted in some cases.

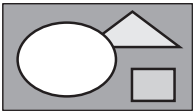
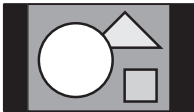
- "Aspect Ratio"
Images are stretched to full screen. Since aspect ratios are maintained, blank horizontal or vertical borders may appear.
- "Dot by Dot"
Displays the image at the set resolution or size specified by the input signal.

Note		
<ul style="list-style-type: none"> • Setting example 		
<p>Full-screen</p> 	<p>Fixed aspect ratio</p> 	<p>Actual size (input signal)</p> 

Sharpness

Settings: "-2" – "2"

When a low-resolution image is displayed using picture expansion mode ("Full Screen" or "Aspect Ratio"), the text and lines of the image may appear blurry. This blurriness can be reduced by configuring the settings for sharpness.

Note
<ul style="list-style-type: none"> • For some display resolutions, it is not necessary to configure the settings for sharpness. ("Sharpness" is not a value that can be selected.)

Input Color Format

Settings: "Auto" / "YUV 4:2:2^{*1}" / "YUV 4:4:4^{*1}" / "YUV^{*2}" / "RGB"

The color format of the input signal can be specified.

Try changing this setting if colors are not displayed correctly.

*1 Only enabled during HDMI input

*2 Only enabled during DisplayPort input

Input Range

Settings: "Auto" / "Full" / "Limited"

Depending on the video reproduction device, there may be a restriction on black and white video signal levels output to the monitor. This kind of signal is called "Limited range". On the other hand, unlimited signals are called "Full range".

- "Auto"
Input signal brightness range is automatically judged and is displayed appropriately (recommended setting). Depending on the video reproduction device, Limited range and Full range may not be able to be judged by the monitor. In such a case, selecting "Full" or "Limited" will allow it to be displayed appropriately.
- "Full"
To be selected in case of Full range signals. Appropriate display can be obtained when this is selected, in case both blacks and whites are corrupted.
- "Limited"
To be selected in case of Limited range signals. In case this is selected, the output signal range is expanded from 0 to 255 to obtain an appropriate display when black is pale and white is dull.

Note

- When "YUV" is selected in "Input Color Format", the setting is automatically set to "Limited". Additionally, when "Auto" is selected and the monitor determines the input color format to be YUV, the setting is automatically set to "Limited".

Analog Adjustment - Auto Screen Adjust

Screen flicker, display position and size and be automatically adjusted. When you select "Auto Screen Adjust", a message will appear. Select "Yes".

Note

- The automatic screen adjustment function will operate correctly if an image is displayed in the entire displayable area of the screen. It will not operate correctly in the following cases:
 - When an image is displayed in only part of a screen like the command prompt
 - When black is used in the background, such as a wallpaper
 Also, when the function may not work correctly in part of the graphics board
- When a signal is input to the monitor for the first time, or when the resolution or horizontal/vertical scan frequency is changed to one that had not been displayed before, it is automatically adjusted (signals with a resolution of 800 x 600 (SVGA) or above).

Analog Adjustment - Auto Range Adjust

The signal output level can be automatically adjusted to enable display of all color gradations (0 to 255). When you select "Auto Range Adjust", a message will appear. Select "Yes".

Analog Adjustment - Clock

Flickering of vertical lines or part of the screen can be minimized.

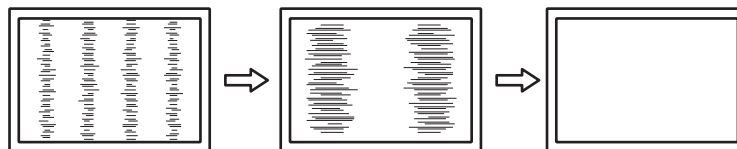
**Note**

- It is easy to overlook the point where the setting is suitable, so please finely adjust.

Analog Adjustment - Phase

Flickering or bleeding of the screen as a whole can be minimized.

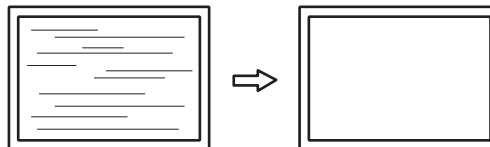
**Note**

- Flickering or bleeding may not fully disappear, depending on the PC and graphics board you are using.
- If vertical stripes appear on the screen after completing the setting, adjust "Clock" again.

Analog Adjustment - Hor. Position / Ver. Position

The display position (horizontal, vertical) of the screen can be adjusted.

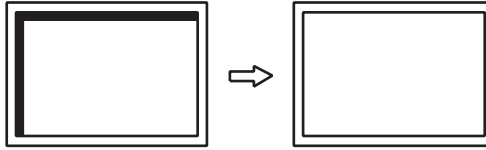

Note

- Since the number of pixels and the pixel positions are fixed on the LCD monitor, only one position is provided to display images correctly. The display position can be adjusted to set the image to its correct position.

3.2.3 Preferences

The monitor's settings can be configured to suit the usage environment or personal preference.

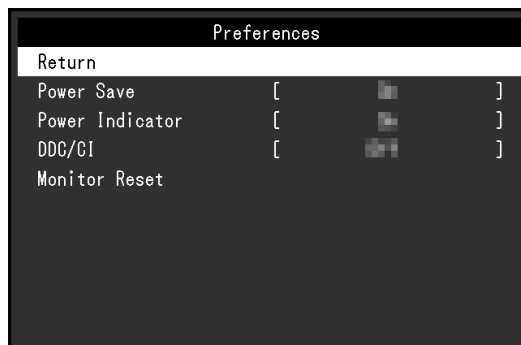

Power Save

Settings: "On" / "Off"

The monitor can be set to enter power saving mode according to the state of the PC.

The monitor changes to power saving mode about 15 seconds after signal input ceases to be detected.

When the monitor has shifted to power saving mode, images are not displayed on the screen.

- Exiting power saving mode
 - Press the  button
 - The monitor automatically exits power saving mode when the monitor receives input

Note

- At the time of shifting to power saving mode, a message that indicates the transition is displayed five seconds in advance.
- When not using the monitor, you can disconnect the power plug so that the power is cut completely.

Power Indicator

Settings: "On" / "Off"

The power indicator (blue) can be turned off in normal operation mode.

DDC/CI

Settings: "On" / "Off"

Switch between enabling or disabling DDC/CI communication.

Monitor Reset

Restores all settings to their default settings except for the following settings:

- Settings on the "Administrator Settings" menu

3.2.4 Languages

Settings: "English" / "German" / "French" / "Spanish" / "Italian" / "Swedish" / "Japanese" / "Simplified Chinese" / "Traditional Chinese"

The display language for menus and messages can be selected.

**Attention**

- The display language of the "Administrator Settings" menu (English) cannot be changed.

3.2.5 Information

You can check the monitor information (model name, serial number (S/N), firmware version, usage time) and the input signal information.

Example:

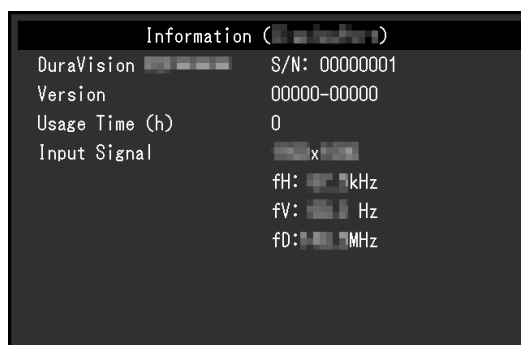

4 Administrator Settings

This chapter describes how to configure monitor operation using the "Administrator Settings" menu.

4.1 Basic Operation of the "Administrator Settings" Menu

1. Press \odot to turn the monitor off .
2. Holding down $\text{\textcircled{S}}$ and pressing $\text{\textcircled{D}}$ for more than 2 seconds will turn on the monitor.
The "Administrator Settings" menu appears.

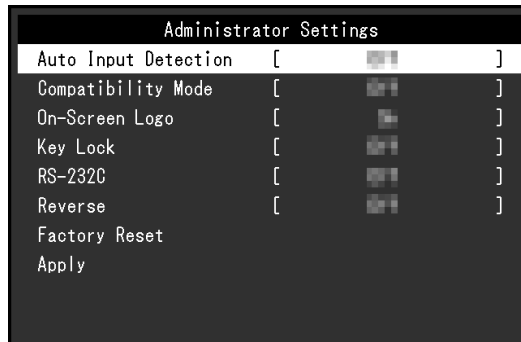

3. Select an item to set with $\text{\textcircled{V}}$ $\text{\textcircled{A}}$ then press $\text{\textcircled{D}}$.
The Adjustment/Setting menu appears.

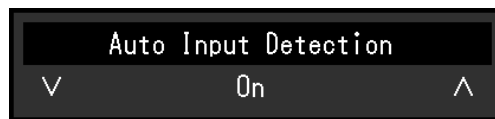

4. Set with $\text{\textcircled{V}}$ $\text{\textcircled{A}}$, then press $\text{\textcircled{D}}$.
The "Administrator Settings" menu appears.
5. Select "Apply" then press $\text{\textcircled{D}}$.
The settings are applied and the "Administrator Settings" menu exits.

Attention

- The language (English) of the "Administrator Settings" menu cannot be changed.

4.2 Functions of the "Administrator Settings" Menu

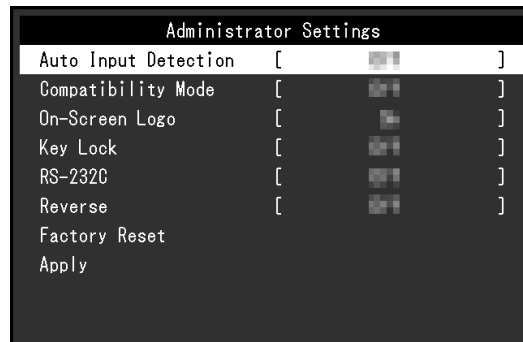

Auto Input Detection

Settings: "On" / "Off"

This function automatically recognizes the connector through which PC signals are input, and displays images on the screen accordingly.

- "On"
When the monitor is connected to multiple PCs, if a specific PC enters power saving mode or no signals are input to the monitor, the connector is automatically changed to another one to which signals are input.
- "Off"
To be set to this when manually selecting input signals. Select the signal to display using the  control button on the front of the monitor. For details, see [2.1 Switching the Input Signal](#) [▶ 5].

Note

- This product automatically recognizes the connector through which PC signals are input, and displays images on the screen accordingly regardless of whether this function is set to On or Off just after the monitor has been turned on.
- When this function is set to "On", the monitor only enters the power saving mode when signals are not input from any PC.

Compatibility Mode

Settings: "On" / "Off"

If you want to avoid the following phenomena, set this function to "On":

- The positions of windows and icons are shifted when the monitor is turned off/on or has returned from the power saving mode.

On-Screen Logo

Settings: "On" / "Off"

When the monitor is turned on, the EIZO logo appears on the screen.

When this function is set to "Off", the EIZO logo does not appear.

Key Lock

Settings: "Off" / "Menu" / "All"

In order to prevent changes to the settings, the operation buttons on the front of the monitor can be locked.

- "Off" (default setting)
Enables all buttons.
- "Menu"
Locks the  button.
- "All"
Locks all buttons except the power button.

RS-232C



Settings: "On" / "Off"

This setting is for when you connect a RS-232C cable and use the touch panel. In the default settings, RS-232C serial transfer is disabled.

- "On"
Enables the RS-232C cable connection.
- "Off"
Disables the RS-232C cable connection.

Reverse

Settings: "On" / "Off"

To flip the screen display upside down, set this function to "On". As the screen display is flipped upside down,   is also inverted.

Factory Reset

Restores the settings to the factory default settings.

5 Troubleshooting

5.1 No Picture

Power indicator does not light up.

- Check whether the power cord is connected properly.
- Press .

Power indicator is lighting white.

- Increase the various adjustment values for "Brightness" and "Gain" in the Setting menu (see [Color \[▶ 7\]](#)).

Power indicator is lighting orange.

- Use  to try switching the input signal.
- Turn the setting "On" for "Compatibility Mode" on the "Administrator Settings" menu (see [Compatibility Mode \[▶ 15\]](#)).
- Move the mouse or press any key on the keyboard.
- Touch the touch panel.
- Check whether the PC is turned on.

The message "No Signal" appears on the screen.

Example:

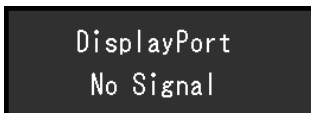

- The message shown above may appear, because some PCs do not output the signal immediately after power-on.
- Check whether the PC is turned on.
- Check whether the signal cable is connected properly.
- Switch the input signal.
- Try setting "Auto Input Detection" in the "Administrator Settings" menu to "Off" and switching the input signal manually (see [Auto Input Detection \[▶ 15\]](#)).

The message "Signal Error" appears on the screen.

Example:

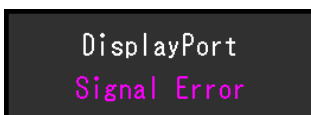

- Check whether the PC is configured to meet the resolution and vertical scan frequency requirements of the monitor (see [6.2 Compatible Resolutions \[▶ 22\]](#)).
- Reboot the PC.
- Select an appropriate setting using the graphics board's utility. Refer to the User's Manual of the graphics board for details.

5.2 Imaging Problems (Digital and Analog)

The screen is too bright or too dark

- Adjust "Brightness" in the Setting menu (see [Color \[▶ 7\]](#)). (The LCD monitor backlight has a limited life span. If the screen becomes dark or begins to flicker, contact your local EIZO representative.)

Letters and images are blurred

- Check whether the PC is configured to meet the resolution and vertical scan frequency requirements of the monitor (see [6.2 Compatible Resolutions \[▶ 22\]](#)).
- Try setting the magnification of display on the OS to "100 %". When using multiple monitors, try setting the magnification of display to "100 %" on all monitors.

Afterimage visible

- Afterimages are particular to LCD monitors. Avoid displaying the same image for a long time.
- Use the screen saver or power saving function to avoid displaying the same image for extended periods of time.
- Depending on the image, an afterimage may appear even if it was displayed for a short period of time. To remove such a phenomenon, change the image or keep the power turned off for several hours.

Green / red / blue / white / dark dots remain on the screen

- This is due to LCD panel characteristics and not a malfunction.

Interference patterns or pressure marks remain on the LCD panel

- Leave the monitor with a white or black screen. The symptom may disappear.

Noise appears on the screen.

- When inputting HDCP system signals, normal images may not be displayed immediately.

The positions of windows and icons are shifted when the monitor is turned off/on or when restored from power saving mode.

- Turn the setting "On" for "Compatibility Mode" on the "Administrator Settings" menu (see [Compatibility Mode \[▶ 15\]](#)).

The color shown on the screen is not correct.

- Try changing "Input Color Format" in the Setting menu (see [Input Color Format \[▶ 10\]](#)).

Images are not displayed over the entire area of the screen.

- Try changing "Picture Expansion" in the Setting menu (see [Picture Expansion \[▶ 9\]](#)).
- Check whether the setting for the resolution of the PC matches the resolution of the monitor.

Fog remains even after wiping the screen / Condensation inside the glass

- If fog remains even after wiping the screen, there may be condensation on the inside of the protective glass on the LCD panel. Wait a while for the condensation to disappear. Even if condensation occurs on the inside of the glass in this manner, it does not cause malfunction or deterioration of the product.

5.3 Imaging Problems (Analog only)

Screen is misaligned



- Use "Hor. Position" or "Ver. Position" in the Setting menu to adjust the positioning of the screen (see [Analog Adjustment - Hor. Position / Ver. Position \[▶ 12\]](#)).
- If the graphics board's utility has a function to change the position of the image, use that function to adjust the position.

Vertical lines appear on the screen / Part of the screen is flickering

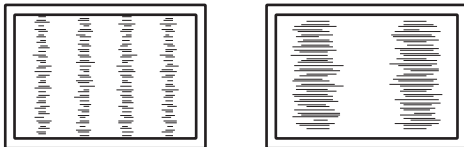

- Try adjusting "Clock" in the Setting menu (see [Analog Adjustment - Clock \[▶ 11\]](#)).

The whole screen appears to flicker or bleed



- Try adjusting "Phase" in the Setting menu (see [Analog Adjustment - Phase \[▶ 11\]](#)).

5.4 Touch Panel Problems

<p>Attention</p> <ul style="list-style-type: none"> • For information on how to install and use the touch panel driver, refer to the User's Manual of the touch panel driver.

The touch and cursor positions are misaligned / The cursor jumps

- Turn off the monitor, and then turn it on again. If the issue is not resolved, adjust the touch position.
- Try to touch with one finger.
- If the "EEPROM" setting in the touch panel driver configuration tool is set to "Use" or "Use EEPROM," adjust the touch position.
- When displaying at a resolution other than the recommended resolution, the touch position and cursor position may become misaligned due to the scaling function of the graphics board. Check the settings of the graphics driver and change the display scaling

from the graphics driver to the monitor. After changing the setting, adjust the touch position again.

Touch operations do not work.

- Connect the monitor to the PC using a cable described in the Setup Manual or User's Manual. The touch panel may not work correctly if a conversion adapter is used.
- If you have changed the cable for the touch panel (from a USB cable to a RS-232C cable or vice versa), turn off the monitor and turn it on again.
- Another logged-in user may have changed the settings. Redo the settings.
- Restart the touch panel driver configuration tool or reboot the PC.
- If you are using a RS-232C cable, restart the PC after connecting the cable. Also, check that the "RS-232C" setting in the "Administrator Settings" menu is set to "On" (see [RS-232C \[▶ 16\]](#)).

Deflection occurs on the surface of the touch panel.

- Due to the structure of the touch panel, deflection may occur on the surface of the touch panel in hot and humid environments. This is not a malfunction.

5.5 Other Problems

The Setting menu does not appear

- Check whether the operation lock function is enabled (see [Key Lock \[▶ 15\]](#)).

Cannot select items in the Setting menu.

- Items displayed in gray text cannot be changed.
- "Color" items cannot be changed in some color modes. Setting the color mode to "User 1" or "User 2" will allow you to change all items (see [Color \[▶ 7\]](#)).

No audio output.

- This product does not contain speakers.

The message "Changes to this setting may increase power consumption." appears on the screen.

Example:

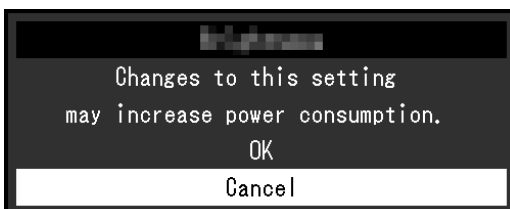

This is a message that will only be displayed during the initial setup when using a function that may potentially increase power consumption. Select "OK" to proceed to the next step.

6 Reference

6.1 Connecting Multiple PCs

This product can be connected to multiple PCs and the display can be switched between the connections.

Connection Examples

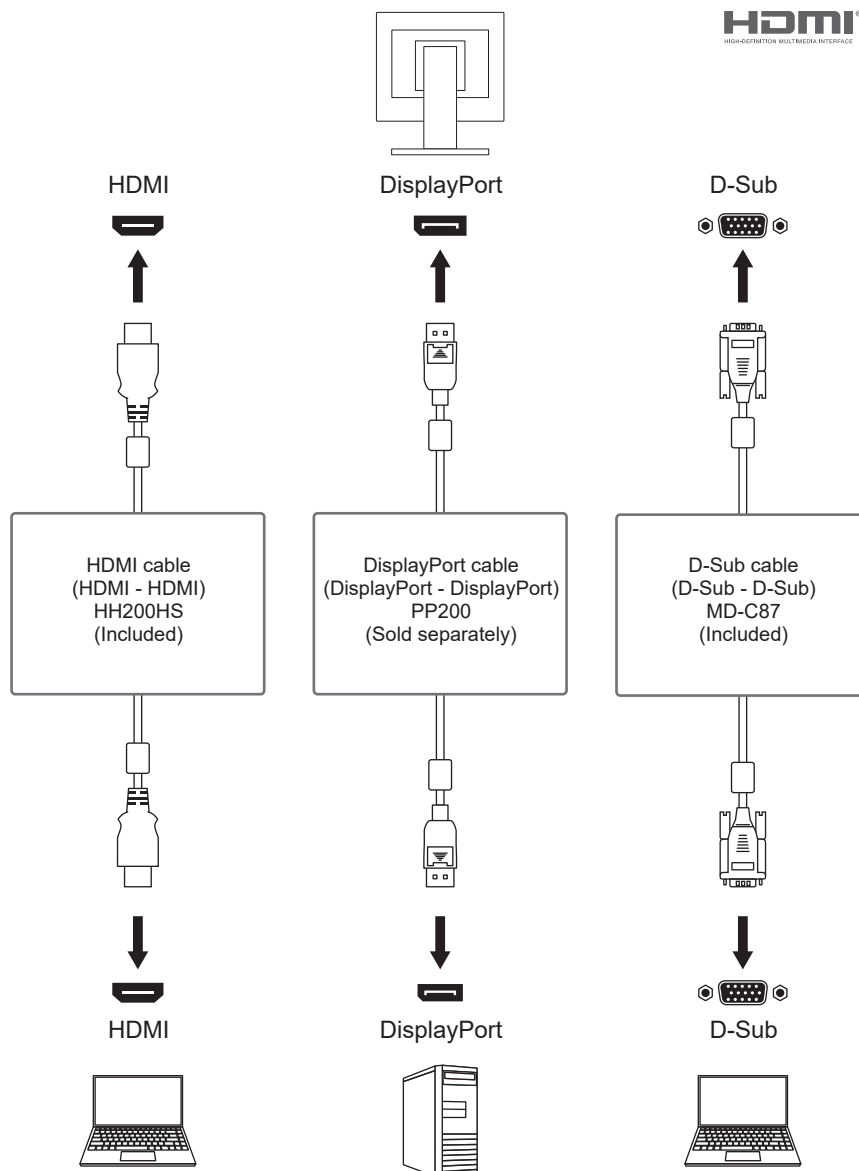

Attention

- The touch panel only works on a USB-connected or RS-232C-connected PC.

Note

- You can select the input signal to display using the  operation button on the rear of the monitor. For details, see [2.1 Switching the Input Signal \[▶ 5\]](#).
- This product provides a function that automatically recognizes the connector through which signals are input, and displays images on the screen accordingly. For details, see [Auto Input Detection \[▶ 15\]](#).

6.2 Compatible Resolutions

The monitor supports the following resolutions.

✓: Supported, -: Not supported

Resolution	Vertical scan frequency (Hz)	DisplayPort	HDMI	D-Sub
640 x 480	59.940	✓	✓	✓
640 x 480	60.000	✓	✓	-
640 x 480	72.809	-	-	✓
640 x 480	75.000	-	-	✓
720 x 400	70.087	✓	✓	✓
720 x 480	59.940	✓	✓	-
720 x 480	60.000	✓	✓	-
800 x 600	56.250	-	-	✓
800 x 600	60.317	✓	✓	✓
800 x 600	72.188	-	-	✓
800 x 600	75.000	-	-	✓
1024 x 768 ^{*1}	60.004	✓	✓	✓
1024 x 768 ^{*1}	70.069	-	-	✓
1024 x 768 ^{*1}	75.029	-	-	✓

*1 Recommended resolution

Note

- Only progressive is supported for the Scan Format.
- 720p/1080p signals are not supported.

Appendix

Trademark

The terms HDMI, HDMI High-Definition Multimedia Interface, HDMI trade dress and the HDMI Logos are trademarks or registered trademarks of HDMI Licensing Administrator, Inc. DisplayPort, the DisplayPort Compliance Logo and VESA are trademarks of the Video Electronics Standards Association in the United States and other countries.

The SuperSpeed USB Trident Logo is a registered trademark of USB Implementers Forum, Inc.



The SuperSpeed USB Power Delivery Trident Logos are trademarks of USB Implementers Forum, Inc.



USB Type-C and USB-C are registered trademarks of USB Implementers Forum, Inc.

DICOM is the registered trademark of the National Electrical Manufacturers Association for its standards publications relating to digital communications of medical information.

Kensington and Microsaver are registered trademarks of ACCO Brands Corporation.

Thunderbolt is a trademark of Intel Corporation in the United States and/or other countries.

Microsoft and Windows are registered trademarks of Microsoft Corporation in the United States and other countries.

Adobe is a registered trademark of Adobe in the United States and other countries.

Apple, macOS, Mac OS, OS X, macOS Sierra, Macintosh and ColorSync are trademarks of Apple Inc.

ENERGY STAR is a registered trademark of the United States Environmental Protection Agency in the United States and other countries.

EIZO, the EIZO Logo, ColorEdge, CuratOR, DuraVision, FlexScan, FORIS, RadiCS, RadiForce, RadiNET, Raptor, and ScreenManager are registered trademarks of EIZO Corporation in Japan and other countries.

ColorEdge Tablet Controller, ColorNavigator, EcoView NET, EIZO EasyPIX, EIZO Monitor Configurator, EIZO ScreenSlicer, G-Ignition, i•Sound, Quick Color Match, RadiLight, Re/Vue, SafeGuard, Screen Administrator, Screen InStyle, ScreenCleaner, SwitchLink, and UniColor Pro are trademarks of EIZO Corporation.

All other company names, product names, and logos are trademarks or registered trademarks of their respective owners.

License

The bitmap font used for this product is designed by Ricoh Industrial Solutions Inc.

