

# User's Manual

## ColorEdge<sup>®</sup>

## CG223W

## CG243W

Calibration Color LCD Monitor

### Important

Please read PRECAUTIONS, this User's Manual, and the Setup Guide (separate volume) carefully to familiarize yourself with safe and effective usage.

- 
- Please refer to the Setup Guide for basic information ranging from connection of the monitor to a PC to using the monitor.
  - The latest User's Manual is available for download from our web site:  
<http://www.eizo.com>
- 



## [Location of Caution Statement]

Ex. CG243W (Height adjustable stand)

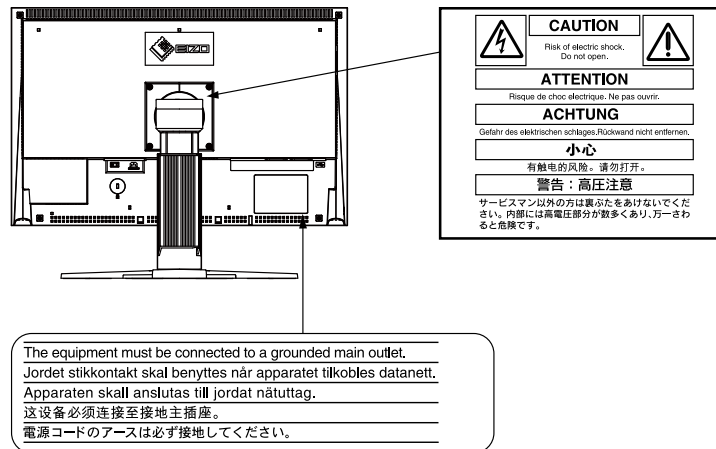

This product has been adjusted specifically for use in the region to which it was originally shipped. If operated outside this region, the product may not perform as stated in the specifications.

This product has acquired the TCO standard that relates to the safety, ergonomics, environment and so forth of office equipment. For an overview of the TCO, refer to our web site.

<http://www.eizo.com>

---

No part of this manual may be reproduced, stored in a retrieval system, or transmitted, in any form or by any means, electronic, mechanical, or otherwise, without the prior written permission of EIZO Corporation. EIZO Corporation is under no obligation to hold any submitted material or information confidential unless prior arrangements are made pursuant to EIZO Corporation's receipt of said information. Although every effort has been made to ensure that this manual provides up-to-date information, please note that EIZO monitor specifications are subject to change without notice.

---

Apple, Mac, Macintosh, iMac, eMac, Mac OS, MacBook, PowerBook, ColorSync, QuickTime, and iBook are registered trademarks of Apple Inc.

Windows, Windows Vista, Windows Media, SQL Server, and Xbox 360 are registered trademarks of Microsoft Corporation in the United States and other countries.

A round gothic bold bit map font designed by Ricoh is used for the characters displayed on this product.

VESA is a registered trademark or a trademark of the Video Electronics Standards Association in the United States and other countries.

EIZO, the EIZO Logo, ColorEdge, DuraVision, FlexScan, FORIS, RadiForce, RadiCS, RadiNET, Raptor, and ScreenManager are registered trademarks of EIZO Corporation in Japan and other countries.

ColorNavigator, EIZO EasyPIX, EcoView NET, EIZO ScreenSlicer, i•Sound, Screen Administrator, and UniColor Pro are trademarks of EIZO Corporation.

All other company and product names are trademarks or registered trademarks of their respective owners.

---

## Notice for this monitor

---

Aside from general purposes like creating documents, viewing multimedia content, this product is also suited to applications such as graphics creation and digital photo processing, where accurate color reproduction is a priority.

---

This product has been adjusted specifically for use in the region to which it was originally shipped. If the product is used outside the region, it may not operate as specified in the specifications.

---

This product may not be covered by warranty for uses other than those described in this manual.

---

The specifications noted in this manual are only applicable when the following are used:

- Power cords provided with the product
  - Signal cables specified by us
- 

Only use optional products manufactured or specified by us with this product.

---

As it takes about 30 minutes for the performance of electrical parts to stabilize, adjust the monitor 30 minutes or more after the monitor power has been turned on.

---

Monitors should be set to a lower brightness to reduce changes in luminosity caused by long-term use and maintain a stable display.

---

When the screen image is changed after displaying the same image for extended periods of time, an afterimage may appear. Use the screen saver or power save function to avoid displaying the same image for extended periods of time.

---

Periodic cleaning is recommended to keep the monitor looking new and to prolong its operation lifetime (Refer to “[Cleaning](#)” on the next page).

---

The LCD panel is manufactured using high-precision technology. Although, missing pixels or lit pixels may appear on the LCD panel, this is not a malfunction. Percentage of effective dots: 99.9994% or higher.

---

The backlight of the LCD panel has a fixed lifetime. When the screen becomes dark or begins to flicker, please contact your dealer.

---

Do not press on the panel or edge of the frame strongly, as this may result in display malfunctions, such as interference patterns, etc. If pressure is continually applied to the panel, it may deteriorate or damage your panel. (If the pressure marks remain on the panel, leave the monitor with a black or white screen. The symptom may disappear.)

---

Do not scratch or press on the panel with any sharp objects, as this may result in damage to the panel. Do not attempt to brush with tissues as this may scratch the panel.

---

When the monitor is cold and brought into a room or the room temperature goes up quickly, dew condensation may occur on the interior and exterior surfaces of the monitor. In that case, do not turn the monitor on. Instead wait until the dew condensation disappears, otherwise it may cause some damage to the monitor.

---

---

## Cleaning

---

### Attention

- Chemicals such as alcohol and antiseptic solution may cause gloss variation, tarnishing, and fading of the cabinet or panel, and also quality deterioration of the image.
  - Never use any thinner, benzene, wax, and abrasive cleaner, which may damage the cabinet or panel.
- 

If necessary, the stains on the cabinet and panel surface can be removed by using the provided ScreenCleaner.

## To use the monitor comfortably

---

- An excessively dark or bright screen may affect your eyes. Adjust the brightness of the monitor according to the environmental conditions.
- Staring at the monitor for a long time tires your eyes. Take a 10-minute rest every hour.

# CONTENTS

<b>Cover</b> .....	<b>1</b>	<b>Chapter 3 Setting Monitor</b> .....	<b>25</b>
Notice for this monitor .....	3	3-1. Enabling/Disabling Mode Selection [Mode Preset] .....	25
<b>CONTENTS</b> .....	<b>5</b>	3-2. Locking Buttons [Key Lock] .....	25
<b>Chapter 1 Introduction</b> .....	<b>6</b>	3-3. Setting the EIZO Logo Display [Logo] .....	26
1-1. Features .....	6	3-4. Setting Orientation [Orientation] .....	26
1-2. Controls and Functions .....	7	3-5. Setting Language [Language] .....	27
1-3. Utility Disk .....	8	3-6. Setting Range of Frequency [Signal Bandwidth] .....	27
● Disk contents and software overview .....	8	3-7. Setting the Display Position of the Adjustment Menu [Menu Position] .....	28
● To use ColorNavigator .....	8	3-8. Restoring the Default Setting .....	28
1-4. Basic Operation and Functions .....	9	● To reset color adjustment values [Color Reset] ..	28
Basic operation of Adjustment menu .....	9	● To reset all adjustments to the factory default settings [All Reset] .....	28
Showing Button Guide .....	10	<b>Chapter 4 Power Saving Function</b> .....	<b>29</b>
Functions .....	11	4-1. Setting the Power Saving [Power Save] .....	29
<b>Chapter 2 Adjusting Screen</b> .....	<b>12</b>	4-2. Setting Power Indicator [Power Indicator] ..	30
2-1. Setting Screen Resolution .....	12	4-3. Setting Monitor's Automatic Brightness Adjustment [Auto EcoView] .....	30
Compatible Resolutions/Frequencies .....	12	<b>Chapter 5 Troubleshooting</b> .....	<b>31</b>
Setting Resolution .....	13	<b>Chapter 6 Reference</b> .....	<b>34</b>
● Windows 8 / Windows 7 .....	13	6-1. Attaching an Arm .....	34
● Windows Vista .....	13	6-2. Connecting More than Two PCs to the Monitor .....	35
● Windows XP .....	13	● To switch the input signal .....	35
● Mac OS X .....	13	● To set input signal selection [Input Selection] ..	36
2-2. Displaying Screen Correctly .....	14	6-3. Making Use of USB (Universal Serial Bus) ..	37
Digital Input .....	14	● Required System Environment .....	37
Analog Input .....	14	● Connection Procedure (Setup of USB Function) ..	37
2-3. Color Adjustment .....	18	6-4. Displaying Monitor Information .....	38
● To select the display mode (Color Mode) .....	18	● Displaying monitor information by pressing ⓘ ...	38
● To perform advanced adjustments .....	19	● Displaying signal information [Signal Info] .....	38
● Adjustment items in each mode .....	19	● Displaying monitor information [Monitor Info] ..	38
● To adjust the brightness [Brightness] .....	20	6-5. Specifications .....	39
● To adjust the contrast [Contrast] .....	20	6-6. Glossary .....	46
● To adjust the color temperature [Temperature] ...	20	6-7. Preset Timing .....	48
● To adjust the gamma value [Gamma] .....	21	<b>About TCO' 03</b> .....	<b>49</b>
● To adjust the hue [Hue] .....	21	<b>FCC Declaration of Conformity</b> .....	<b>50</b>
● To adjust the color saturation [Saturation] .....	21	<b>Hinweise zur Auswahl des richtigen Schwenkarms für Ihren Monitor</b> .....	<b>51</b>
● To enhance the outline of the image [Outline Enhancer] .....	22		
● To adjust the gain value [Gain] .....	22		
● To adjust the black level [Black Level] .....	22		
● To adjust six colors [6 Colors] .....	23		
2-4. Displaying Lower Resolutions .....	24		
● To change screen size [Screen Size] .....	24		
2-5. Configuring moving image performance [Overdrive] (CG243W) .....	24		

# Chapter 1 Introduction

Thank you very much for choosing an EIZO Color Monitor.

## 1-1. Features

- 22" wide format LCD (CG223W) / 24" wide format LCD (CG243W)
- Wide color gamut of 95% of Adobe RGB (CG223W) / 98% (CG243W)
- Applicable to the resolution of 1680 dots x 1050 lines (CG223W) / 1920 dots x 1200 lines (CG243W)
- HDCP (High-bandwidth Digital Content Protection)
- Frame Synchronous mode supported : 47.5 - 61Hz (CG223W)  
: 23.75 - 30.5Hz, 47.5 - 61Hz (CG243W)
- Applicable to DisplayPort (applicable to 8 bit or 10 bit, not applicable to audio signals)
- 3 signal input terminals (DVI-I x 2, DisplayPort x 1)
- Color Mode function reproduces color gamut and gamma compliant with [EBU/REC.709/SMPTE-C] broadcasting standards as well as the [DCI] digital cinema standard  
"2-3. To select the display mode (Color Mode)" (page 18)
- Attaching the "Adjustment Certificate" to describe the grayscale and uniformity characteristics of the monitor individually
- Portrait/Landscape display available (rotate 90 degrees clockwise)
- Monitor hood attached
- The provided Color Management Software "ColorNavigator" enables you to calibrate monitor characteristics and generate color profiles  
"1-3. Utility Disk" (page 8)
- Color Vision Deficiency Simulation Software "UniColor Pro" supported  
This software can be downloaded from <http://www.eizo.com>
- Power saving function  
This product is equipped with power saving function.
  - Power Consumption when main power switch is Off: 0W  
Equipped with main power switch.  
Turning off the main power switch completely shuts off power supply to the monitor while the monitor is not used.
  - Auto EcoView function  
The sensor on the front side of the monitor detects the environmental brightness to adjust the screen brightness automatically and comfortably.  
Excessively high brightness may lead a damage to the natural environment as well as to your eyes. Suppressing the excessively high brightness will be helpful to reduce the power consumption and the damage to your eyes.  
"4-3. Setting Monitor's Automatic Brightness Adjustment" (page 30)

---

### NOTE

- This monitor supports the Portrait/Landscape display. This function allows you to change the orientation of the Adjustment menu when using the monitor screen in vertical display position. (Refer to "To set the orientation of the Adjustment menu [Orientation]" on page 26.)
  - For using the monitor with "Portrait" position, the graphics board supporting portrait display is required. When using the monitor with "Portrait" position, the setting needs to be changed depending on the graphics board used in your PC. Refer to the manual of the graphics board for details.
-

# 1-2. Controls and Functions

Ex. CG243W (Height adjustable stand)

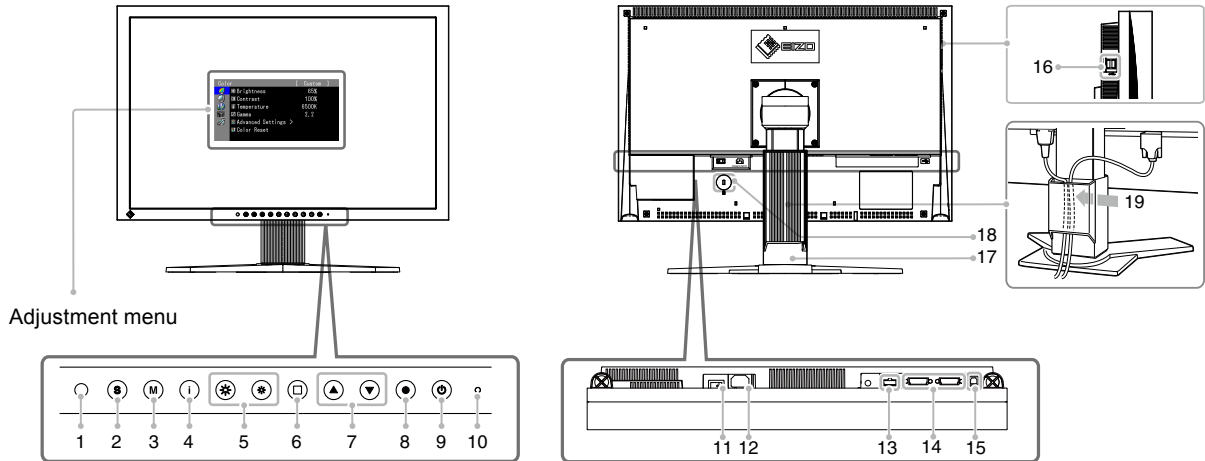

1	Sensor (AutoEcoView)	Detects ambient brightness. Auto EcoView function
2	Ⓢ button	Switches input signals for display when more than two PCs are connected to the monitor.
3	Ⓜ button	Allows you to switch the Color Mode.
4	ⓘ button	Displays the information about monitor or input signals.
5	☀☀ button	Adjusts the brightness.
6	⊞ button	Cancels the adjustment/setting or exit the adjustment menu.
7	▲▼ buttons	Chooses an adjustment item or increases/decreases adjusted values for advanced adjustments using the Adjustment menu.
8	⦿ button	Displays the Adjustment menu, determines an item on the menu screen, and saves values adjusted.
9	Ⓞ button	Turns the power on or off.
10	Power indicator	Indicates monitor's operation status. Blue : Operating Flashing blue : When the timer is set for ColorNavigator, notifies (2 times for each) that a recalibration is required (for CAL mode). Orange : Power saving Off : Power off
11	Main Power switch	Turns the main power on or off.
12	Power connector	Connects the power cord.
13	Input signal connectors	Display Port Connector x 1
14	Input signal connectors	DVI-I Connector x 2
15	USB port (Up)	Connects the USB cable to use the software that needs USB connection, or to use USB Hub function.
16	USB port (Down)	Connects a peripheral USB drive.
17	Stand	Used to adjust the height and angle of the monitor screen.
18	Security lock slot	Complies with Kensington's MicroSaver security system.
19	Cable holder	Covers the monitor cables.

## 1-3. Utility Disk

An “EIZO LCD Utility Disk” (CD-ROM) is supplied with the monitor. The following table shows the disk contents and the overview of the software programs.

### ● Disk contents and software overview

The disk includes application software programs for adjustment, and User’s Manual. Refer to "Readme.txt" or the "read me" file on the disk for software startup procedures or file access procedures.

Item	Overview	For Windows	For Macintosh
A “Readme.txt” or “read me” file		√	√
ColorNavigator	An application software for calibrating monitor characteristics and generating ICC profiles (for Windows) and Apple ColorSync profiles (for Macintosh). (A PC must be connected to the monitor with the supplied USB cable.) Refer to the description later.	√	√
Screen adjustment pattern files	Used when adjusting the image of the analog signal input manually.	√	–
User’s Manual (PDF file)		√	√

### ● To use ColorNavigator

Refer to the corresponding User’s Manual on the CD-ROM disk in order to install and use the software. When using this software, you will need to connect a PC to the monitor with the supplied USB cable. For more information refer to the “6-3. Making Use of USB (Universal Serial Bus)” ([page 37](#)).



# 1- 4. Basic Operation and Functions

## Basic operation of Adjustment menu

### 1 Displaying Adjustment Menu

Press  $\odot$ .

The adjustment menu appears.

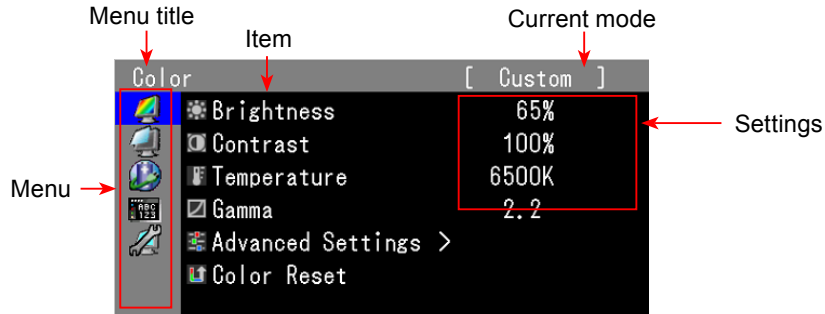

### 2 Adjusting/Setting

1. Choose a menu to adjust/set with  $\uparrow$ / $\downarrow$ , and press  $\odot$ .

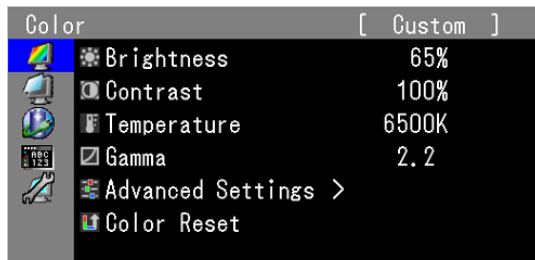

2. Choose an item to adjust/set with  $\uparrow$ / $\downarrow$ , and press  $\odot$ .

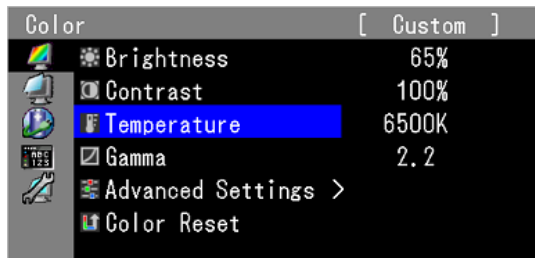

3. Adjust/set the selected item with  $\uparrow$ / $\downarrow$ , and press  $\odot$ .

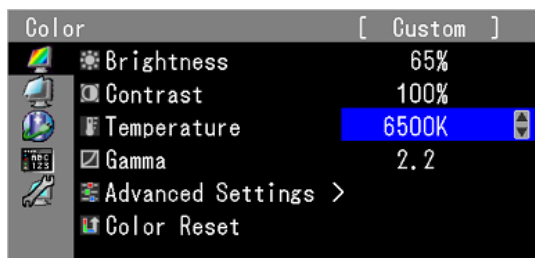

### 3 Exiting

Press  $\odot$  a few times.

The adjustment menu finishes.



## Showing Button Guide

---

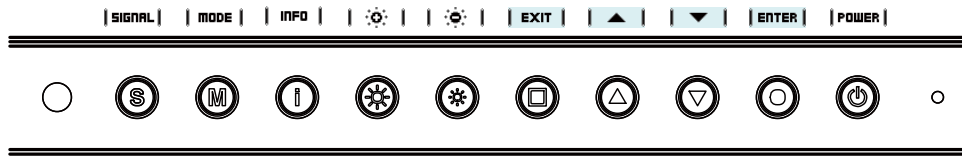
Press the front buttons (except  button), the button guide appears above the button. (When using the monitor with "Portrait" position, the button guide appears next to the button.)







### NOTE

- The button guide will continue to appear while the Adjustment menu or Mode menu is showing.
- The button guide is displayed differently depending on the selected menu or status.
- In CAL mode, although Button Guide are displayed above the  and  buttons, the brightness cannot be adjusted.

## Functions

The following table shows all the Adjustment menu's adjustment and setting menus.

Main Menu	Item	Adjusting/Setting	
Color 	Brightness	"2-3. Color Adjustment" (page 18)	
	Contrast		
	Temperature		
	Gamma		
	Advanced Settings		Hue
	Saturation		
	Outline Enhancer		
	Gain	Black Level	
6 Colors			
Color Reset		"3-8. Restoring the Default Setting" (page 28)	
Screen 	Screen Size	"2-4. Displaying Lower Resolutions" (page 24)	
	Analog Adjustment	Auto Adjustment	"2-2. Displaying Screen Correctly" (page 14)
	Range Adjustment		
	Clock		
	Phase		
	Hor.Position		
	Ver.Position		
PowerManager 	Power Save	"4-1. Setting the Power Saving" (page 29)	
	Auto EcoView	"4-3. Setting Monitor's Automatic Brightness Adjustment" (page 30)	
	Power Indicator	"4-2. Setting Power Indicator" (page 30)	
Menu Settings 	Language	"3-5. Setting Language" (page 27)	
	Orientation	"3-4. Setting Orientation" (page 26)	
	Menu Position	"3-7. Setting the Display Position of the Adjustment Menu" (page 28)	
Tools 	Input Selection	"6-2. Connecting More than Two PCs to the Monitor" (page 35)	
	Overdrive (CG243W)	"2-5. Configuring moving image performance" (page 24)	
	Mode Preset	"3-1. Enabling/Disabling Mode Selection" (page 25)	
	Signal Info	"6-4. Displaying Monitor Information" (page 38)	
	Monitor Info		
	All Reset	"3-8. Restoring the Default Setting" (page 28)	

\* The adjusting/setting function on the <Color> menu depend on the selected Color mode (page 19). The above table shows the sub menus when the "Custom" mode is selected (See "2-3. Color Adjustment" (page 18)).

# Chapter 2 Adjusting Screen

## 2-1. Setting Screen Resolution

### Compatible Resolutions/Frequencies

The monitor supports the following resolutions.

Analog Input

Resolution	Applicable signal	Frequency	Dot Clock	CG223W	CG243W
640×480	VGA	60Hz	170MHz (Max.)	√	√
720×400	VGA TEXT	70Hz		√	√
800×600	VESA	60Hz		√	√
1024×768	VESA	60Hz		√	√
1024×768	VESA	~ 75Hz		√	—
1024×768	VESA	85Hz		√	—
1152×864	VESA	75Hz		√	—
1280×960	VESA	60Hz		√	√
1280×1024	VESA	60Hz		√	√
1600×1200	VESA	60Hz		—	√
1680×1050*1	VESA CVT	60Hz		√	√
1680×1050*1	VESA CVT RB	60Hz		√	—
1920×1200*2	VESA CVT RB	60Hz		—	√

Digital Input (DVI/DisplayPort)

Resolution	Applicable signal	Frequency	Dot Clock	CG223W	CG243W
640×480	VGA	60Hz	164.5MHz (Max.)	√	√
720×400	VGA TEXT	70Hz		√	√
800×600	VESA	60Hz		√	√
1024×768	VESA	60Hz		√	√
1280×960	VESA	60Hz		√	√
1280×1024	VESA	60Hz		√	√
1600×1200	VESA	60Hz		√	√
1680×1050*1	VESA CVT	60Hz		—	√
1680×1050*1	VESA CVT RB	60Hz		√	√
1920×1200*2	VESA CVT RB	60Hz		—	√

A graphics board in conformance with VESA standard is required.

\*1 Recommended resolution (CG223W : Set this resolution).

\*2 Recommended resolution (CG243W : Set this resolution).

## Setting Resolution

---

When you connect the monitor to the PC and find that the resolution is improper, or when you want to change the resolution, follow the procedure below.

### ● Windows 8 / Windows 7

1. For Windows 8, click the “Desktop” tile on the Start Screen to display the desktop.
2. Right-click the mouse anywhere on the desktop except for icons.
3. From the displayed menu, click “Screen resolution”.
4. On the "Screen Resolution" dialog, select the monitor .
5. Click "Resolution" to select the desired resolution.
6. Click the [OK] button.
7. When a confirmation dialog is displayed, click [Keep changes].

### ● Windows Vista

1. Right-click the mouse anywhere on the desktop except for icons.
2. From the displayed menu, click “Personalize”.
3. On the “Personalization” window, click “Display Settings”.
4. On the “Display Settings” dialog, select the “Monitor” tab and select desired resolution in the “Resolution” field.
5. Click the [OK] button.
6. When a confirmation dialog is displayed, click [Yes].

### ● Windows XP

1. Right-click the mouse anywhere on the desktop except for icons.
2. From the displayed menu, click “Properties”.
3. When the “Display Properties” dialog is displayed, click the “Settings” tab and select desired resolution for “Screen resolution” under “Display”.
4. Click the [OK] button to close the dialog.

### ● Mac OS X

1. Select “System Preferences” from the Apple menu.
2. When the “System Preferences” dialog is displayed, click “Displays” for “Hardware”.
3. On the displayed dialog, select the “Display” tab and select desired resolution in the “Resolutions” field.
4. Your selection will be reflected immediately. When you are satisfied with the selected resolution, close the window.

## 2-2. Displaying Screen Correctly

### Digital Input

When digital signals are input, images are displayed correctly based on the preset data of the monitor. When performing advanced adjustment, see “2-3 Color Adjustment” (page 18) and subsequent pages.

### Analog Input

#### Attention

- Wait 30 minutes or more from monitor power on before starting adjustments.  
(Allow the monitor to warm up for at least 30 minutes before making adjustments.)

The monitor screen adjustment is used to suppress flickering of the screen or adjust screen position and screen size correctly according to the PC to be used.

- The auto adjustment function works when filling/satisfying all of the following conditions
- When a signal is input into the monitor for the first time or when the resolution or Vertical/Horizontal Frequency not displayed before is set
  - When signals with the vertical resolution over 480 are input

If the screen is not displayed correctly even after performing the auto adjustment, perform the screen adjustments according to the procedures on the following pages to use the monitor comfortably.

### [Adjustment Procedure]

#### 1 Perform the auto adjustment.

- To adjust flickering, screen position, and screen size automatically [Auto Adjustment]

#### Procedure

1. Choose <Screen> from the Adjustment menu, and press .
2. Choose <Analog Adjustment> from the <Screen> menu, and press .
3. Choose <Auto Adjustment>, and press .

The auto adjustment function works (the message “In Progress” appears) to correctly adjust the flickering, screen position, and screen size correctly.

When the auto adjustment is completed, a message appears. Select “OK” to confirm the new settings or “Cancel” to restore the previous settings, and press .

#### Attention

- This function works correctly when an image is fully displayed over the Windows or Macintosh display area. It does not work properly when an image is displayed only on a part of the screen (command prompt window, for example) or when a black background (wallpaper, etc.) is in use.
- This function does not work correctly with some graphics boards.

If the screen is not displayed correctly even after adjusting in step 1 above, perform the adjustments according to the procedures on the following pages. When the screen is displayed correctly, go to [step 5](#) “To adjust color gradation automatically [Range]”.

## 2 Prepare the display pattern for the analog display adjustment.

Load the “EIZO LCD Utility Disk” to your PC, and then open the “Screen adjustment pattern files”.

### NOTE

- For details and instructions on opening the “Screen adjustment pattern files”, refer to the “Readme.txt” file.

## 3 Perform the auto adjustment again with the analog screen adjustment pattern displayed.

### ● To adjust flickering, screen position, and screen size automatically [Auto Adjustment]

#### Procedure

1. Display Pattern 1 of the “Screen adjustment pattern files” in full screen on the monitor.

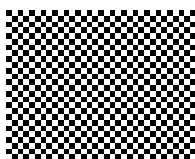

2. Choose <Screen> from the Adjustment menu, and press .
3. Choose <Analog Adjustment> from the <Screen> menu, and press .  
To proceed with the subsequent adjustments, select an item in <Analog Adjustment> of the <Screen> menu.
4. Choose <Auto Adjustment>, and press .  
The auto adjustment function works (the message “In Progress” appears) to adjust the flickering, screen position, and screen size correctly.  
When the auto adjustment is completed, a message appears. Select “OK” to confirm the new settings or “Cancel” to restore the previous settings, and press .

If the screen is not displayed correctly even after adjusting in step 3 above, perform the adjustments according to the procedures on the following pages. When the screen is displayed correctly, go to [step 5](#) “To adjust color gradation automatically [Range]”.

## 4 Perform advanced adjustments for the following using the <Screen> menu of the <Analog Adjustment>.

Adjust the clock, phase and position, in this order.

### ● To eliminate vertical bars [Clock]

#### Procedure

1. Choose <Clock> from the <Analog Adjustment> menu, and press ●.
2. Adjust the clock with ▲ or ▼.  
Press ▲▼ slowly so as not to miss the adjustment point.
3. Press ● to exit the adjustment.  
When blurring, flickering or bars appear on the screen after adjustment, proceed to [Phase] to remove flickering or blurring.

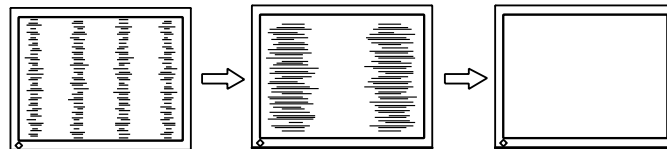

### ● Remove flickering or blurring [Phase]

#### Procedure

1. Choose <Phase> from the <Analog Adjustment> menu, and press ●.
2. Adjust the phase with ▲ or ▼.
3. Press ● to exit the adjustment.

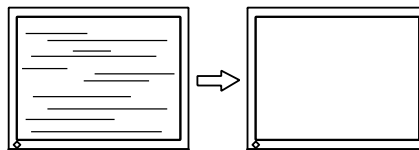

---

#### Attention

- Flickering or blurring may not be eliminated depending on your PC or graphics board.
- 

### ● To correct screen position [Hor.Position] [Ver.Position]

---

#### NOTE

- Since the number of pixels and the pixel positions are fixed on the LCD monitor, only one position is provided to display images correctly. The position adjustment is made to shift an image to the correct position.
- 

#### Procedure

1. Choose <Hor.Position> or <Ver.Position> from the <Analog Adjustment> menu, and press ●.
2. Adjust the position with ▲ or ▼.
3. Press ● to exit the adjustment.

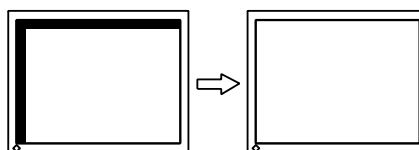



## 5 Adjust the color gradation.

### ● To adjust color gradation automatically [Range Adjustment]

Every color gradation (0 to 255) can be displayed by adjusting the signal output level.

#### **Procedure**

1. Display Pattern 2 in full screen on the monitor using the “Screen adjustment pattern files”.

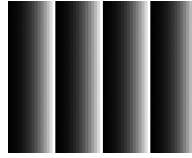

2. Choose <Range> from the <Analog Adjustment> menu, and press .  
The color gradation is adjusted automatically.  
When the auto adjustment is completed, a message appears. Select “OK” to confirm the new settings or “Cancel” to restore the precious settings, and press .
3. Close the Pattern 2.

## 2-3. Color Adjustment

### ● To select the display mode (Color Mode)

Color Mode allows you to select easily the adequate mode suitable for the monitor's application.

#### Color Mode

Mode	Purpose
1-Custom	Available for the color settings according to your preference.
2-sRGB	Suitable for color matching with sRGB compatible peripherals.
3-EBU	Suitable for reproducing the color gamut and gamma as set forth by EBU (European Broadcasting Union) standards.
4-REC709	Suitable for reproducing the color gamut and gamma as set forth by the ITU-R Rec. 709 standard.
5-SMPTE-C	Suitable for reproducing the color gamut and gamma as set forth by SMPTE-C standards.
6-DCI	Suitable for reproducing the color gamut and gamma as set forth by DCI standards.
7-CAL1 8-CAL2 9-CAL3	Displays the screen adjusted by Color Management Software "ColorNavigator".

#### Attention

- "CAL" mode can be adjusted only by "ColorNavigator".
- With default settings only one CAL mode can be selected for every input signal displayed.
- A CAL mode will be chosen by the ColorNavigator in accordance with the displayed input signal.
- Avoid operating any function of the monitor while using ColorNavigator.

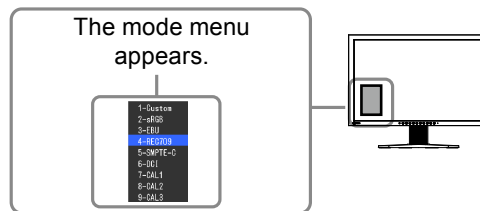

#### Procedure

1. Press **(M)**.  
Mode menu appears at the lower left of the screen.
2. The mode among the list is highlighted in turn each time **(M)** is pressed.  
You can switch the current mode with **(▲)** or **(▼)** while the mode menu is being displayed.

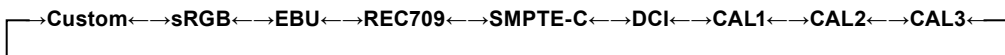

#### NOTE

- The Adjustment menu and the Mode menu cannot be displayed at the same time.
- You can disable a specific mode to be selected. For more information, refer to "3-1 Enabling/Disabling Mode Selection" (page 25).

## ● To perform advanced adjustments

The <Color> menu of the Adjustment menu allows you to set and save the independent color adjustment for each mode.

### Attention

- Wait 30 minutes or more from monitor power on before starting the color adjustment.  
(Allow the monitor to warm up for at least 30 minutes before making adjustments.)
- Perform the range adjustment first when adjusting color for analog input signals.  
(Refer to “To adjust color gradation automatically” on [page 17](#)).
- The same image may be seen in different colors on multiple monitors due to their monitor-specific characteristics.  
Make fine color adjustment visually when matching colors on multiple monitors.

### NOTE

- The values shown in “%” or “K” are available only as reference.

## ● Adjustment items in each mode

According to the mode selected, the adjustable function differs.

(You can not select any function unavailable for adjustment or setting.)

The adjustments or settings made for each mode are applied to all input signals.

For the adjustment method of each function, refer to subsequent pages.

√: Adjustment available —: Invalid for adjustment





Icon	Function	Color Mode						
		1-Custom	2-sRGB	3-EBU	4-REC709	5-SMPTE-C	6-DCI	7-CAL1 8-CAL2 9-CAL3
	Brightness	√	√	√	√	√	√	—
	Contrast	√	—	—	—	—	—	—
	Temperature	√	√	√	√	√	√	—
	Gamma	√	√	√	√	√	√	—
	Hue	√	—	—	—	—	—	—
	Saturation	√	—	—	—	—	—	—
	Outline Enhancer	√	√	√	√	√	√	—
	Gain	√	—	—	—	—	—	—
	Black Level	√	√	√	√	√	√	—
	6 Colors	√	—	—	—	—	—	—
	Color Reset	√	√	√	√	√	√	—

## ● To adjust the brightness [Brightness]

The screen brightness is adjusted by changing the brightness of the backlight (Light source from the LCD back panel).



Adjustable range: 0 to 100%

### Procedure

1. Choose <Color> from the Adjustment menu, and press .
2. Choose <Brightness> from the <Color> menu, and press .
3. Adjust the brightness with  or .
4. Press  to exit the adjustment.

---

#### NOTE





- You can also adjust the brightness using  and .
  - When you feel the image is bright even if the brightness is set to 0%, adjust the contrast.
- 

## ● To adjust the contrast [Contrast]

The luminance of the screen is adjusted by varying the video signal level.

Adjustable range: 0 to 100%

### Procedure

1. Choose <Color> from the Adjustment menu, and press .
2. Choose <Contrast> from the <Color> menu, and press .
3. Adjust the contrast with  or .
4. Press  to exit the adjustment.

---

#### NOTE





- In the contrast of 100%, every color gradation is displayed.
  - When adjusting the monitor, it is recommended to perform the brightness adjustment which may not lose the gradation characteristics, prior to the contrast adjustment.
  - Perform the contrast adjustment in the following cases.
    - When you feel the image is bright even if the brightness is set to 0%. (Set the contrast to lower than 100%).
- 

## ● To adjust the color temperature [Temperature]

The color temperature can be adjusted. The color temperature is normally used to express the hue of "White" and/or "Black" by a numerical value. The value is expressed in degrees "K" (Kelvin). In the same way as the flame temperature, the image on the monitor is displayed reddish if the color temperature is low and is bluish if the color temperature is high. The gain preset values are set for each color temperature setting value.

Adjustable range: Standard, Native, 4000K-10000K (specified by every 500K unit, including 5400K, 9300K)

### Procedure

1. Choose <Color> from the Adjustment menu, and press .
2. Choose <Temperature> from the <Color> menu, and press .
3. Adjust the color temperature with  or .
4. Press  to exit the adjustment.

---

#### NOTE





- [Gain] allows you to perform more advanced adjustment (See "To adjust the gain value" on [page 22](#)).
  - If you set to [Native], the image is displayed in the preset color of the monitor (Gain: 100% for each RGB).
  - When changing the gain value, the color temperature adjusting range is changed to "User".
  - The default setting for each sRGB/EBU/REC709/SMPTE-C/DCI mode is set to "Standard", which is the temperature in conformity with each standard.
-

## ● To adjust the gamma value [Gamma]

The gamma value can be adjusted. The luminance of the monitor varies depending on the input signal, however, the variation rate is not proportional to the input signal. To keep the balance between the input signal and the luminance of the monitor is called as "Gamma correction".

Adjustable range: 1.8-2.6

### Procedure

1. Choose <Color> from the Adjustment menu, and press .
2. Choose <Gamma> from the <Color> menu, and press .
3. Adjust the gamma value with  or .
4. Press  to exit the adjustment.

---

#### NOTE







- The default setting for each sRGB/EBU/REC709/SMPTE-C/DCI mode is set to "Standard", which is the gamma in conformity with each standard.
- 

## ● To adjust the hue [Hue]

This function allows you to adjust the hue.

Adjustable range: -100 to 100

### Procedure

1. Choose <Color> from the Adjustment menu, and press .
2. Choose <Advanced Settings> from the <Color> menu, and press .
3. Choose <Hue>, and press .
4. Adjust the hue with  or .
5. Press  to exit the adjustment.

---

#### Attention







- This function does not enable to display every color gradation.
- 

## ● To adjust the color saturation [Saturation]

This function allows you to adjust the saturation of the color on the monitor.

Adjustable range: -100 to 100

### Procedure

1. Choose <Color> from the Adjustment menu, and press .
2. Choose <Advanced Settings> from the <Color> menu, and press .
3. Choose <Saturation>, and press .
4. Adjust the saturation of the color with  or .
5. Press  to exit the adjustment.

---

#### Attention

- This function does not enable to display every color gradation.
- 

---

#### NOTE







- Setting the minimum (-100) turns the image to a monochrome screen.
-

## ● To enhance the outline of the image [Outline Enhancer]

OutlineEnhancer functions to emphasize outline of the images by emphasizing the color difference between pixels composing the images. This may improve the texture of the material and its feel of the images.

On the contrary, it also functions to reproduce the images smoothly by gradating its outline.

### **Procedure**







1. Choose <Color> from the Adjustment menu, and press .
2. Choose <Advanced Settings> from the <Color> menu, and press .
3. Choose <Outline Enhancer> and press .
4. Select the display status in the range from -3 to 3 (soft to sharp) with  or  as desired.
5. Press  to exit the adjustment.

## ● To adjust the gain value [Gain]

Each luminance of red/green/blue composing the color is called “Gain”. The gain adjustment may change the color tone of the “White” (when the max input signal for each color is obtained)

Adjustable range: 0 to 100%

### **Procedure**

1. Choose <Color> from the Adjustment menu, and press .
2. Choose <Advanced Settings> from the <Color> menu, and press .
3. Choose <Gain>, and press .
4. Choose the color for adjustment among <Red>, <Green>, or <Blue> to adjust, and press .
5. Adjust the gain with  or .
6. Press  to exit the adjustment.

---

### **NOTE**







- The <Temperature> setting invalidates this setting.
  - The gain value may change depending on the value of the color temperature.
  - When changing the gain value, the color temperature adjusting range is changed to “User”.
- 

## ● To adjust the black level [Black Level]

The brightness of black and chromaticity can be adjusted based on the respective black level of red, green and blue. Adjust the black level by showing images with black background.

Adjustable range: 0 to 100%

### **Procedure**

1. Choose <Color> from the Adjustment menu, and press .
2. Choose <Advanced Settings> from the <Color> menu, and press .
3. Choose <Black Level>, and press .
4. Choose the color for adjustment among <Red>, <Green>, or <Blue> to adjust, and press .
5. Adjust the black level with  or .
6. Press  to exit the adjustment.

---

### **NOTE**









- To further darken the black when the value of the black level is 0, lower the brightness value.
  - Lowering the contrast value will not change the brightness of the black level.
-

## ● To adjust six colors [6 Colors]

The hue and saturation can be adjusted for each of six colors: Magenta, Red, Yellow, Green, Cyan, and Blue.

Adjustable range: -100 to 100

### **Procedure**

1. Choose <Color> from the Adjustment menu, and press .
2. Choose <Advanced Settings> from the <Color> menu, and press .
3. Choose <6 Colors>, and press .
4. Choose the color for adjustment among <Magenta>, <Red>, <Yellow>, <Green>, <Cyan>, or <Blue>, and press .
5. Select <Hue> or <Saturation>, and press .
6. Adjust the 6 colors with  or .
7. Press  to exit the adjustment.

## 2-4. Displaying Lower Resolutions

### ● To change screen size [Screen Size]

The image with the resolution other than the recommended resolution is displayed in full screen automatically. You can change the screen size by using <Screen Size> from <Screen> menu.

Menu	Function
Full (default setting)	Displays an image in full screen. Images are distorted in some cases because the vertical rate is not equal to the horizontal rate.
Enlarged	Displays an image in full screen. In some cases, a blank horizontal or vertical border appears to equalize the vertical rate and the horizontal rate.
Normal	Displays images with the specified resolution.

Example: Image size 1280 x 1024 in case of CG243W

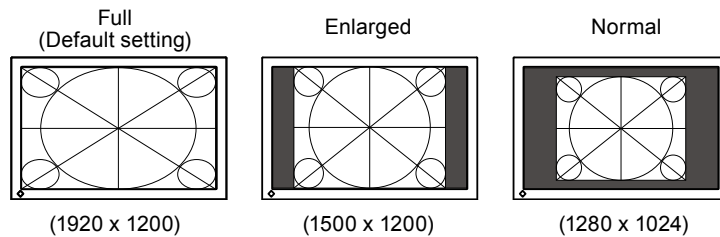

### Procedure

1. Choose <Screen> from the Adjustment menu, and press .
2. Choose <Screen Size> from the <Screen> menu, and press .
3. Select "Full Screen," "Enlarged," or "Normal" with  or .
4. Press  to exit the adjustment.

## 2-5. Configuring moving image performance [Overdrive] (CG243W)

By using the <Overdrive> setting, the extent to which fast moving images produce visible afterimages can be reduced. This setting is set to "On" by default, but while turned "On" noise and afterimages may instead be more noticeable. In such a case, please set the <Overdrive> setting to "Off".

### Procedure

1. Choose <Tools> from the Adjustment menu, and press .
2. Choose <Overdrive> from the <Tools> menu, and press .
3. Select "On" or "Off" with  or .
4. Press  to exit the adjustment.











# Chapter 3 Setting Monitor

## 3-1. Enabling/Disabling Mode Selection [Mode Preset] .....

Allows you to select the specified modes only.

Use this function when all the display modes are not available or when keeping the display mode unchanged.

### Procedure

1. Choose <Tools> from the Adjustment menu, and press .
2. Choose <Mode Preset> from the <Tools> menu, and press .
3. Select the mode to change its settings with  or , and press .
4. Select “On” or “Off” with  or .
5. Press  to exit the adjustment.







### Attention



- You cannot set all the modes disable. Set at least one mode to “On”.



## 3-2. Locking Buttons [Key Lock] .....

This function allows you to lock to prevent changing the adjusted/set status.

### Procedure

1. Press  to turn off the monitor.
2. Press  holding  down for at least 2 seconds to turn on the monitor.  
The Optional Settings menu appears.
3. Choose <Key Lock> from the <Optional Settings> menu, and press .
4. Select “Off”, “Menu”, or “All” with  or , and press .

Settings	Buttons that can be locked
Off (Initial settings)	None (All buttons are enabled)
Menu	 button
All	All buttons excluding 

5. Select “Finish” with  or .
6. Press  to exit.  
The Optional Settings menu is closed.

### 3-3. Setting the EIZO Logo Display [Logo]

The EIZO logo appears on the display when turning on the monitor. This function allows you to display, or not, the EIZO logo.

#### Procedure

1. Press **⏻** to turn off the monitor.
2. Press **M** holding **⏻** down at least 2 seconds to turn on the monitor.

The Optional Settings menu appears.

3. Choose <Logo> from the <Optional Settings> menu, and press **⏻**.
4. Select “On” or “Off” with **▲** or **▼**, and press **⏻**.
5. Select “Finish” with **▲** or **▼**.
6. Press **⏻** to exit the Optional Settings.

The Optional Settings menu is closed.

### 3-4. Setting Orientation [Orientation]

This function allows you to change the orientation of the Adjustment menu when using the monitor screen in vertical display position. (Default settings : Landscape)

#### Procedure

1. Choose <Menu Settings> from the Adjustment menu, and press **⏻**.
2. Choose <Orientation> from the <Menu Settings> menu, and press **⏻**.
3. Select “Landscape” or “Portrait” with **▲** or **▼**.
4. Press **⏻** to exit the adjustment.
5. When selecting “Portrait”, turn the monitor screen 90° in clockwise direction.

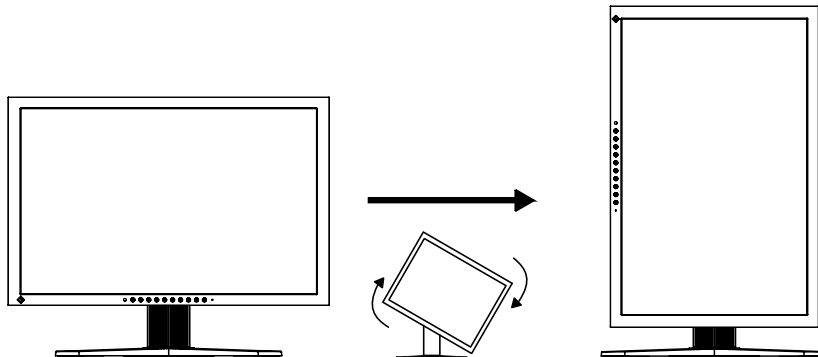

#### Attention

- Be sure that the cables are correctly connected.

#### NOTE

- For using the monitor with “Portrait” position, the graphics board supporting portrait display is required. When placing the monitor in a "Portrait" position, settings of your graphics board need to be changed. Refer to the manual of the graphics board for details.

## 3-5. Setting Language [Language]

This function allows you to select a language for the adjustment menu or displaying message.

### Selectable languages

English/German/French/Spanish/Italian/Swedish/Japanese /Simplified Chinese/Traditional Chinese

#### Procedure

1. Choose <Menu Settings> menu from the Adjustment menu, and press **⏻**.
2. Choose <Language> from the <Menu Settings> menu, and press **⏻**.
3. Choose a language with **⬆** or **⬇**.
4. Press **⏻** to exit the adjustment.

## 3-6. Setting Range of Frequency [Signal Bandwidth]

Depending upon your operating environment, it may be necessary to set the frequency that corresponds to your graphics board. If you install it for the first time or change environment, set the monitor.

#### NOTE

- Refer to the manual of the graphics board.
- These environment described below can be set regardless of whether or not the computer is running.
- Only digital input signals can be set up.

#### Procedure

1. Press **⏻** to turn off the monitor.
2. Press **Ⓜ** holding down **⏻** at least 2 seconds to turn on the monitor.  
The Optional Settings menu appears.
3. Choose <Signal Bandwidth> from the <Optional Settings> menu, and press **⏻**.  
Select "Normal" or "Wide" with **⬆** or **⬇**, and press **⏻**.

Use **⬆** or **⬇** to select (or just confirm) the frequency that corresponds to your graphics board.

CG223W

Setting	Horizontal scanning frequency (kHz)	Vertical scanning frequency (Hz)
Normal	31 - 65	59 - 61
Wide	31 - 65	47.5 - 61

CG243W

Setting	Horizontal scanning frequency (kHz)	Vertical scanning frequency (Hz)
Normal	26 - 78	59 - 61
Wide-1	26 - 78	23.75 - 63
Wide-2/-3 *	Used when inputting a special signal.	

\*: Wide-2/-3 cannot be selected when using DisplayPort.

4. Select "Finish" with **⬆** or **⬇**.
5. Press **⏻** to exit the Optional Settings.  
The Optional Settings menu is closed.

## 3-7. Setting the Display Position of the Adjustment Menu [Menu Position]

Adjust the menu position using the following procedure.

### Procedure

1. Choose <Menu Settings> from the Adjustment menu, and press **⏏**.
2. Choose <Menu Position> from the <Menu Settings> menu, and press **⏏**.
3. Select a menu position with **▲** or **▼**.
4. Press **⏏** to exit the adjustment.

## 3-8. Restoring the Default Setting

There are two types of Reset. One is to reset the color adjustment only to the default settings, and the other is to reset all the settings to the default settings.

### Attention

- After resetting, you cannot undo the operation.

### NOTE

- For main default settings, refer to “Main default settings (factory settings)” on [page 41](#).

### ● To reset color adjustment values [Color Reset]

Only the adjustment values in the current mode will revert to the default settings (factory settings).

### Procedure

1. Choose <Color> from the Adjustment menu, and press **⏏**.
2. Choose <Color Reset> from the <Color> menu and press **⏏**.
3. Select “Execute” with **▲** or **▼**.
4. Press **⏏**.  
The color adjustment values revert to the default settings.

### ● To reset all adjustments to the factory default settings [All Reset]

Reset all adjustments to the factory default settings.

### Procedure

1. Choose <Tools> from the Adjustment menu, and press **⏏**.
2. Choose <All Reset> from the <Tools> menu, and press **⏏**.
3. Select “Execute” with **▲** or **▼**.
4. Press **⏏**.  
All setting values revert to the default settings.

# Chapter 4 Power Saving Function

## 4-1. Setting the Power Saving [Power Save]

This function allows you to set the monitor into the power saving mode according to the PC status. When the monitor enters the power saving mode, no image is displayed on the screen.





### Attention

- Turning off the main power switch or unplugging the power cord completely shuts off power supply to the monitor.
- Devices connected to the USB port (upstream and downstream) work when the monitor is in power saving mode or when the power button of the monitor is Off. Therefore, power consumption of the monitor varies with connected devices even in the power saving mode.

Power Save is compliant with the following standards for the respective signal inputs.

signal inputs		Standard
Analog signal		VESA DPM
Digital signal	DVI	DVI DMPM
	DisplayPort	DisplayPort Standard V1.1a

### Procedure

1. Choose <PowerManager> from the Adjustment menu, and press .
2. Choose <Power Save> from the <PowerManager> menu, and press .
3. Select “On” or “Off” with  or .
4. Press  to exit the adjustment.

### Power Saving System





The monitor enters the power saving mode in conjunction with the PC settings.

PC		Monitor Power	Indicator
Operating		Operating	Blue
Power saving	STAND-BY SUSPENDED OFF	Power saving	Orange

## 4-2. Setting Power Indicator [Power Indicator]

The brightness of the power indicator (blue) when the screen is displayed can be adjusted (default setting is set to light up when power is turned on, and brightness is set to 4).

### Procedure

1. Choose <PowerManager> from the Adjustment menu, and press .
2. Choose <Power Indicator> from the <PowerManager> menu, and press .
3. Select the indicator brightness “Off” or in the range from 1 to 7 with  or  as desired.
4. Press  to exit the adjustment.

## 4-3. Setting Monitor’s Automatic Brightness Adjustment [Auto EcoView]





The sensor on the lower side of the monitor detects the environmental brightness to adjust the screen brightness automatically and comfortably by using the Auto EcoView function.

---

### Attention

- The Auto EcoView function is not available in CAL mode.
  - Be careful not to block the sensor on the lower side of the monitor when using the Auto EcoView function.
- 





### Procedure



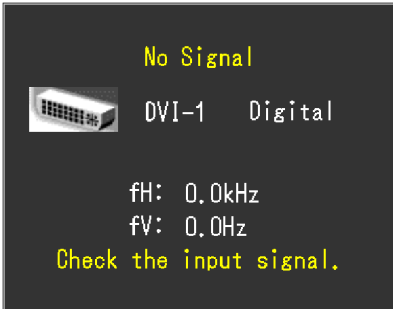

1. Choose <PowerManager> from the Adjustment menu, and press .
2. Choose <Auto EcoView> from the <PowerManager> menu, and press .
3. Select “On” or “Off” with  or .
4. Press  to exit the adjustment.

# Chapter 5 Troubleshooting

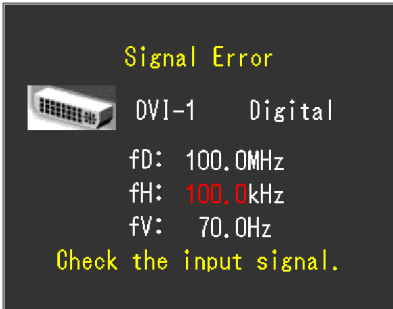
If a problem still remains after applying the suggested remedies, contact your local dealer.

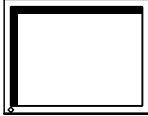
- No-picture problems → See No.1 - No.2.
- Imaging problems (digital input) → See No.3 - No.8.
- Imaging problems (analog input) → See No.3 - No.12.
- Other problems → See No.13 - No.16.

Problems	Possible cause and remedy
<p><b>1. No picture</b></p> <ul style="list-style-type: none"> <li>• Power indicator does not light.</li> </ul>	<ul style="list-style-type: none"> <li>• Check whether the power cord is connected correctly.</li> <li>• Turn off the main power, and then turn it on again a few minutes later.</li> <li>• Turn the main power switch on.</li> <li>• Press .</li> </ul>
<ul style="list-style-type: none"> <li>• Power indicator lights blue.</li> </ul>	<ul style="list-style-type: none"> <li>• Set each adjusting value in &lt;Brightness&gt;, &lt;Contrast&gt; and &lt;Gain&gt; to higher level. (page 20, 22)</li> </ul>
<ul style="list-style-type: none"> <li>• Power indicator lights orange.</li> </ul>	<ul style="list-style-type: none"> <li>• Switch the input signal with .</li> <li>• Operate the mouse or keyboard.</li> <li>• Check whether the PC is turned on.</li> </ul>
<p><b>2. The message below appears.</b></p> <ul style="list-style-type: none"> <li>• This message appears when no signal is input. Example:</li> </ul> 	<p>This message appears when the signal is not input correctly even when the monitor functions properly.</p> <ul style="list-style-type: none"> <li>• The message shown left may appear, because some PCs do not output the signal soon after power-on.</li> <li>• Check whether the PC is turned on.</li> <li>• Check whether the signal cable is connected properly.</li> <li>• Switch the input signal with .</li> </ul>
<ul style="list-style-type: none"> <li>• The message shows that the input signal is out of the specified frequency range. (Such signal frequency is displayed in red.) Example:</li> </ul> 	<ul style="list-style-type: none"> <li>• Check whether the signal setting of your PC matches the resolution and the vertical frequency settings for the monitor. (refer to the Setup Manual "Setting Screen Resolution")</li> <li>• Reboot the PC.</li> <li>• Select an appropriate display mode using the graphics board's utility. Refer to the manual of the graphics board for details.</li> </ul> <p>fD : Dot Clock (Displayed only when the digital signal inputs)</p> <p>fH : Horizontal Frequency fV : Vertical Frequency</p>
<p><b>3. The screen is too bright or too dark.</b></p>	<ul style="list-style-type: none"> <li>• Adjust using &lt;Brightness&gt; or &lt;Contrast&gt;. (The LCD monitor backlight has a fixed life span. When the screen becomes dark or begins to flicker, contact your local dealer.)</li> <li>• Turn on the Auto EcoView function. The monitor detects the environmental brightness to adjust the screen brightness automatically.</li> </ul>

Problems	Possible cause and remedy
<b>4. Characters are blurred</b>	<ul style="list-style-type: none"> <li>• Check whether the signal setting of your PC matches the resolution and the vertical frequency settings for the monitor. (refer to the Setup Manual “Setting Screen Resolution”)</li> <li>• Adjust using &lt;Outline Enhancer&gt;. (page 22)</li> </ul>
<b>5. Afterimages appear</b>	<ul style="list-style-type: none"> <li>• Afterimages are particular to LCD monitors. Avoid displaying the same image for a long time.</li> <li>• Use the screen saver or power save function to avoid displaying the same image for extended periods of time.</li> </ul>
<b>6. Green/red/blue/white dots or defective dots remain on the screen.</b>	<ul style="list-style-type: none"> <li>• This is due to LCD panel characteristics and is not a failure.</li> </ul>
<b>7. Interference patterns or pressure marks remain on the screen.</b>	<ul style="list-style-type: none"> <li>• Leave the monitor with a white or black screen. The symptom may disappear.</li> </ul>
<b>8. Noise appears on the screen.</b>	<ul style="list-style-type: none"> <li>• When entering the signals of HDCP system, the normal images may not be displayed immediately.</li> </ul>
<b>9. Display position is incorrect.</b> 	<ul style="list-style-type: none"> <li>• Adjust image position using &lt;Hor.Position&gt; or &lt;Ver.Position&gt;. (page 16)</li> <li>• If the problem persists, use the graphics board's utility if available to change the display position.</li> </ul>
<b>10. Vertical bars appear on the screen or a part of the image is flickering.</b> 	<ul style="list-style-type: none"> <li>• Adjust using &lt;Clock&gt;. (page 16)</li> </ul>
<b>11. Whole screen is flickering or blurring.</b> 	<ul style="list-style-type: none"> <li>• Adjust using &lt;Phase&gt;. (page 16)</li> </ul>
<b>12. Upper part of the screen is distorted as shown below.</b> 	<ul style="list-style-type: none"> <li>• This is caused when both composite sync (X-OR) signal and separate vertical sync signal are input simultaneously. Select either composite signal or separate signal.</li> </ul>
<b>13. The adjustment menu does not appear.</b>	<ul style="list-style-type: none"> <li>• Check whether the operation lock function works. (page 25)</li> </ul>
<b>14. Mode menu does not appear.</b>	<ul style="list-style-type: none"> <li>• Check whether the operation lock function works. (page 25)</li> </ul>
<b>15. The auto adjust function does not work correctly.</b>	<ul style="list-style-type: none"> <li>• This function does not work when digital signal is input.</li> <li>• This function is intended for use on the Macintosh and on AT-compatible PC running Windows. It may not work properly in either of the following cases. It does not work properly when an image is displayed only on a part of the screen (command prompt window, for example) or when a black background (wallpaper, etc.) is in use.</li> <li>• This function does not work correctly with some graphics boards.</li> </ul>



Problems	Possible cause and remedy
<p><b>16. The monitor connected with the USB cable is not detected. / USB devices connected to the monitor does not work.</b></p>	<ul style="list-style-type: none"> <li>• Check whether the USB cable is connected correctly. (<a href="#">page 37</a>)</li> <li>• Change the USB port to another one. If the PC or peripheral devices works correctly by changing the USB port, contact your local dealer. (Refer to the manual of the PC for details.)</li> <li>• Reboot the PC.</li> <li>• If the peripheral devices work correctly when the PC and peripheral devices are connected directly, please contact your local dealer.</li> <li>• Check whether the PC and OS are USB compliant. (For USB compliance of the respective devices, consult their manufacturers.)</li> <li>• Check the PC's BIOS setting for USB when using Windows. (Refer to the manual of the PC for details.)</li> </ul>

# Chapter 6 Reference

## 6-1. Attaching an Arm

The stand can be removed and replaced with an arm (or another stand) to be attached to the monitor. Use an arm or stand of EIZO option.

### Attention

- When attaching an arm or stand, follow the instructions of their user's manual.
- When using another manufacturer's arm or stand, confirm the following in advance and select one conforming to the VESA standard.
  - Clearance between the screw holes: 100 mm × 100 mm
  - Thickness of plate: 2.6 mm
  - Strong enough to support weight of the monitor unit (except the stand) and attachments such as cables.Use the screws as described below.
  - FlexStand: The screws fixing the stand to the monitor
  - Height adjustable stand: The screws supplied with this monitor (M4 × 12mm)
- When using an arm or stand, attach it to meet the following tilt angles of the monitor.
  - Up 45 degrees, down 45 degrees (horizontal display, and vertical display rotated 90 degrees clockwise)
- Connect the cables after attaching an arm.
- Do not adjust the height of the stand removed from the monitor. When adjusted without attached monitor, it causes the personnel injury or the damaged to the stand.
- Since the monitor and arm are so heavy, dropping them may result in injury or equipment damage.

### [Attachment Procedure]

**1 Lay the LCD monitor on a soft cloth spread over on a stable surface with the panel surface facing down.**

**2 Remove the stand.**

Prepare a screwdriver. Unscrew the four screws securing the unit and the stand with the screwdriver.

**3 Attach the monitor to the arm or stand.**

Secure the monitor to the arm or stand using the screws specified in the user's manual of the arm or stand.

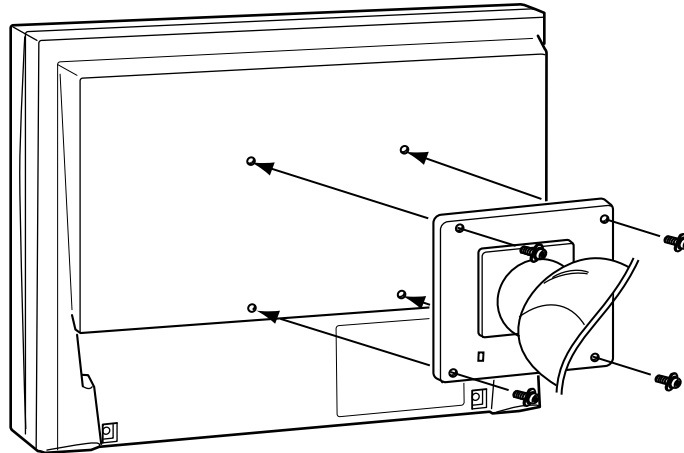

## 6-2. Connecting More than Two PCs to the Monitor

More than two PCs can be connected to the monitor through the DVI-I and the DisplayPort connector on the back of the monitor.

### Connection examples

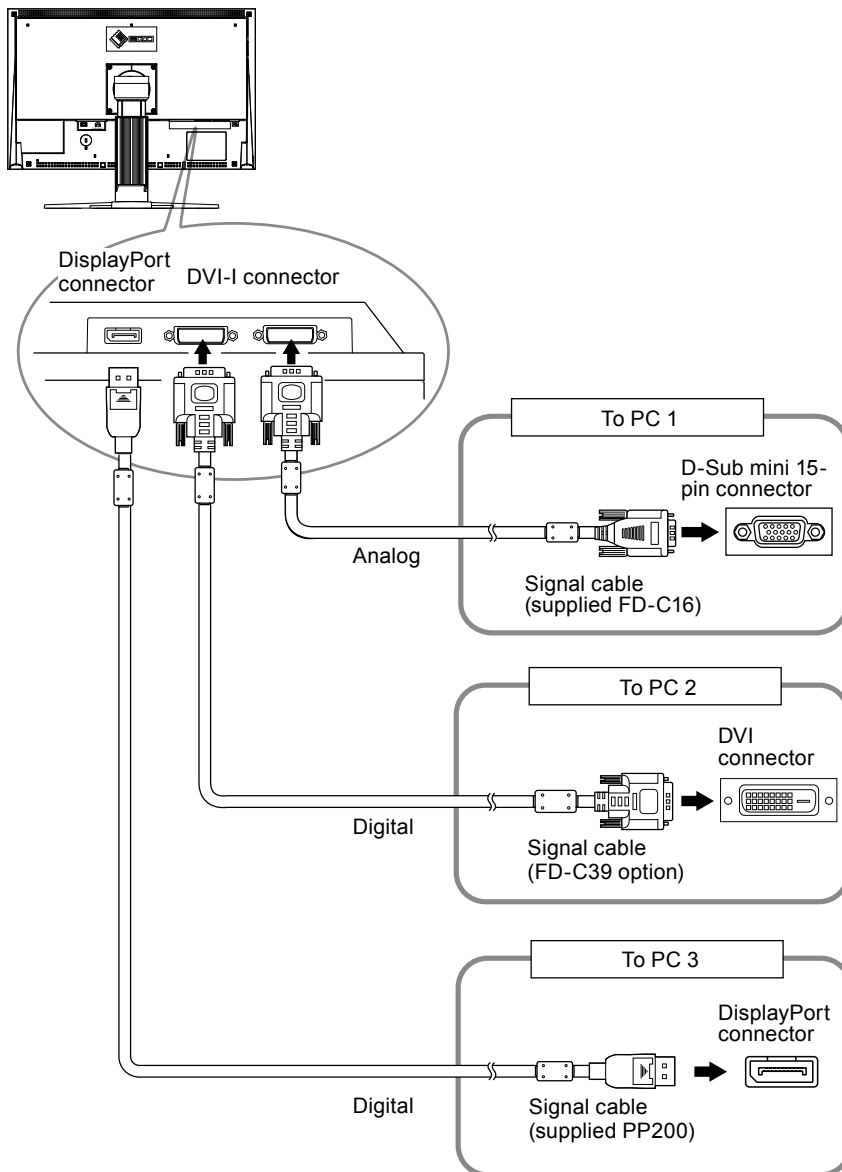

#### ● To switch the input signal

The input signal switches each time **(S)** is pressed.

When the signal is switched, the active input port name appears at the top right corner of the screen.

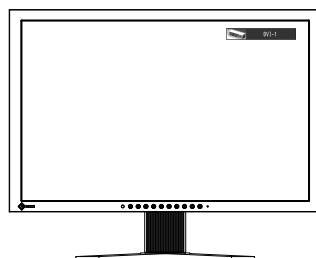

## ● To set input signal selection [Input Selection]

The monitor recognizes the connector through which PC signals are input.

Priority setting	Function
Auto	When a PC is turned off or enters the powersaving mode, the monitor automatically displays another signal.
Manual	The monitor detects only the PC's signals currently displaying automatically. Select an active input signal with <b>S</b> .

### Procedure

1. Choose <Tools> from the Adjustment menu, and press **●**.
2. Choose <Input Selection> from the <Tools> menu, and press **●**.  
The <Input Selection> menu appears.
3. Select "Auto" or "Manual" with **▲** or **▼**.
4. Press **●** to exit the adjustment.

---

### Attention

- When "Auto" is selected for <Input Selection>, the monitor's power-saving function works only when the all PCs are in the power-saving mode.
-

## 6-3. Making Use of USB (Universal Serial Bus)

This monitor has a hub compatible with USB. Connected to a PC compatible with USB or another USB hub, this monitor functions as a USB hub allowing connection to peripheral USB devices.

### ● Required System Environment

1. A PC equipped with a USB port or another USB hub connected to a USB compatible PC
2. Windows 8 / Windows 7 / Windows Vista / Windows XP / Windows 2000 or Mac OS X 10.2 or later and Mac OS 9.2.2
3. EIZO USB cable (MD-C93)

---

#### Attention

- This monitor may not work depending on PC, OS or peripheral devices to be used. For USB compatibility of peripheral devices, contact their manufactures.
  - Devices connected to the USB port (upstream and downstream) work when the monitor is in power saving mode or when the power button of the monitor is Off. Therefore, power consumption of the monitor varies with connected devices even in the power saving mode.
  - When the main power switch is Off, device connected to the USB port will not operate.
- 

### ● Connection Procedure (Setup of USB Function)

1. Connect the monitor first to a PC using the signal cable, and run the PC.
2. Connect the supplied USB cable between the downstream USB port of a USB compatible PC (or another USB hub) and the monitor's upstream USB port.  
The USB hub function is set up automatically upon connection of the USB cable.
3. Connect the peripheral USB device to the USB port (downstream) of the monitor.

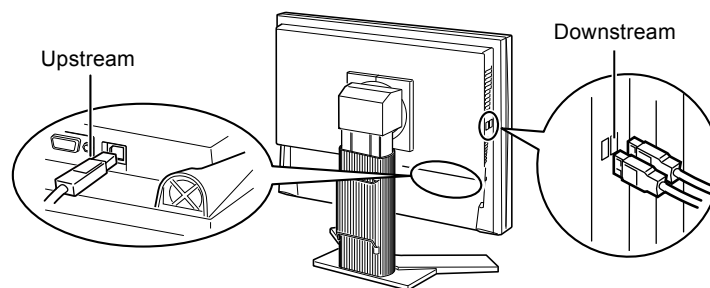

## 6-4. Displaying Monitor Information

### ● Displaying monitor information by pressing ⓘ

The ⓘ displays the information about the monitor and the current input signals displayed.  
(Example)

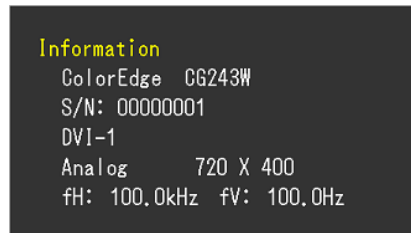

### ● Displaying signal information [Signal Info]

This function displays the information about the current input signals displayed.

1. Choose <Tools> from the Adjustment menu, and press ⓪.
2. Choose <Signal Info> from the <Tools> menu, and press ⓪.

The Signal Info screen appears.

(Example)

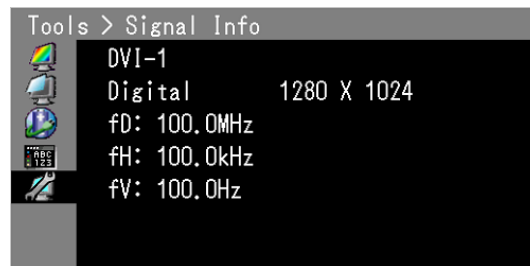

### ● Displaying monitor information [Monitor Info]

This function displays the information about the monitor.

1. Choose <Tools> from the Adjustment menu, and press ⓪.
2. Choose <Monitor Info> from the <Tools> menu, and press ⓪.

The Monitor Info screen appears.

(Example)

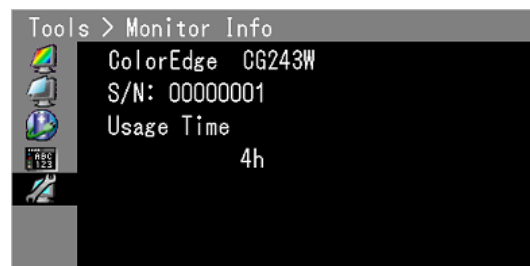

---

#### Attention

- The usage time is not always "0" due to factory inspection when you purchase the monitor.
-

## 6-5. Specifications

CG223W

LCD Panel	Size	22.0-inch (560 mm) TFT color LCD		
	Surface treatment	Anti-Glare Hard Coating		
	Surface hardness	3H		
	Viewing angle	Viewing angle : Horizontal 178°, Vertical 178° (CR:10 or more)		
	Dot Pitch	0.282 mm		
	Response Time	Approx. 12ms		
Horizontal Scan Frequency	Analog	24-82 kHz		
	Digital	31-65 kHz		
Vertical Scan Frequency	Analog	47.5-86 Hz (1280 × 1024: ~ 76 Hz, 1680 × 1050: ~ 61 Hz)		
	Digital	47.5-61 Hz (VGA TEXT: 69-71 Hz)		
	Frame Synchronous mode	Analog	47.5-61 Hz	
		Digital	47.5-61 Hz	
Resolution	1680 dots × 1050 lines			
Recommended Brightness	120 cd/m <sup>2</sup> or less (with color temperature of between 5000K to 6500K)			
Max. Dot Clock	Analog	150 MHz		
	Digital	120 MHz		
Max. Display Color	Approx. 1073.74 million colors (DisplayPort 10bit)			
Display Area (H × V)	473.76 mm × 296.1 mm			
Power Supply	100-120/200-240 VAC ±10%, 50/60Hz, 0.85A/0.45A			
Power Consumption	Screen Display On	85W or less (with USB load) 75W or less (without USB load)		
	Power saving mode	0.9W or less (for DVI-I (Analog) single signal input, without USB load, [Input Selection] : "Manual")		
	Power button Off	0.7W or less (without USB load)		
	Main Power switch Off	0W		
Input Signal Connector	DVI-I connector (Applicable to HDCP) × 2			
	DisplayPort (Standard V1.1a, applicable to HDCP)			
Analog Input Signal (Sync)	Separate, TTL, positive/ negative Composite, TTL, positive/ negative			
Analog Input Signal (Video)	Analog, Positive (0.7Vp-p/75Ω)			
Digital Signal (DVI) Transmission System	TMDS (Single Link)			
Max. Video Signal Memory	Analog	45 (preset: 12)		
Plug & Play	Analog / Digital (DVI-I) : VESA DDC 2B / EDID structure 1.3 Digital (DisplayPort) : VESA DisplayPort / EDID structure 1.4			
Dimensions	Main unit	511 mm (20.1 inch) × 347.5-521.5 mm (13.7 – 20.5 inch) × 240.5 mm (9.5 inch)		
	Main unit (without stand)	511 mm (20.1 inch) × 333 mm (13.1 inch) × 85 mm (3.35 inch)		
Mass	Main unit	Approx. 9.6 kg (21.2 lbs.)		
	Main unit (without stand)	Approx. 6.6 kg (14.6 lbs.)		

Movable range	Tilt	30° Up, 0° Down
	Swivel	172° Right, 172° Left
	Adjustable height	225 mm (8.9 inch) (174 mm (6.9 inch) when Tilt is 0°)
	Rotation	90° (clockwise)
Environmental Conditions	Temperature	Operating: 0 °C - 35 °C (32 °F - 95 °F) Transportation/Storage: -20 °C - 60 °C (-4 °F - 140 °F)
	Humidity	Operating: 20% - 80% R.H. (no condensation) Transportation/Storage: 10% - 80% R.H. (no condensation)
	Pressure	Operating: 700 to 1,060 hPa Transportation/Storage: 200 to 1,060 hPa
USB	Standard	USB Specification Revision 2.0
	Port	Upstream port × 1, Downstream port × 2
	Communication Speed	480 Mbps (high), 12 Mbps (full), 1.5 Mbps (low)
	Supply current	Downstream: Max. 500mA/1 port

### CG243W

LCD Panel	Size	24.1-inch (610 mm) TFT color LCD		
	Surface treatment	Hard Coating		
	Surface hardness	3H		
	Viewing angle	Viewing angle : Horizontal 178°, Vertical 178° (CR:10 or more)		
	Dot Pitch	0.270 mm		
	Response Time	Approx. 13ms		
Horizontal Scan Frequency	Analog	24-76 kHz		
	Digital	26-78 kHz		
Vertical Scan Frequency	Analog	47.5-86 Hz(1600 × 1200, 1920 × 1200: 47.5-61 Hz)		
	Digital	23.75-63 Hz (VGA TEXT: 69-71 Hz)		
	Frame Synchronous mode	Analog	47.5-61 Hz	
		Digital	23.75-30.5 Hz, 47.5-61 Hz	
Resolution		1920 dots × 1200 lines		
Recommended Brightness		120 cd/m <sup>2</sup> or less (with color temperature of between 5000K to 6500K)		
Max. Dot Clock	Analog	170 MHz		
	Digital	164.5 MHz		
Max. Display Color		Approx. 1073.74 million colors (DisplayPort 10bit)		
Display Area (H × V)		518.4 mm × 324.0 mm		
Power Supply		100-120/200-240 VAC ±10%, 50/60Hz, 1.0A/0.5A		
Power Consumption	Screen Display On	95W or less (with USB load) 85W or less (without USB load)		
	Power saving mode	0.9W or less (for DVI-I (Analog) single signal input, without USB load, [Input Selection] : "Manual")		
	Power button Off	0.7W or less (without USB load)		
	Main Power switch Off	0W		
Input Signal Connector		DVI-I connector (Applicable to HDCP) × 2		
		DisplayPort (Standard V1.1a, applicable to HDCP)		



Analog Input Signal (Sync)		Separate, TTL, positive/ negative Composite, TTL, positive/ negative
Analog Input Signal (Video)		Analog, Positive (0.7Vp-p/75Ω)
Digital Signal (DVI) Transmission System		TMDS (Single Link)
Max. Video Signal Memory	Analog	45 (preset: 9)
Plug & Play		Analog / Digital (DVI-I) : VESA DDC 2B / EDID structure 1.3 Digital (DisplayPort) : VESA DisplayPort / EDID structure 1.4
Dimensions	Main unit (Height adjustable stand)	566 mm (22.3 inch) × 456 - 538 mm (18.0 - 21.2 inch) × 230 mm (9.1 inch)
	Main unit (FlexStand)	566 mm (22.3 inch) × 381.5 - 538.5 mm (15.0 - 21.2 inch) × 242 - 256 mm (9.5 - 10.1 inch)
	Main unit (without stand)	566 mm (22.3 inch) × 367 mm (14.4 inch) × 85 mm (3.4 inch)
Mass	Main unit (Height adjustable stand)	Approx. 10.7 kg (23.6 lbs.)
	Main unit (FlexStand)	Approx. 10.1 kg (22.3 lbs.)
	Main unit (without stand)	Approx. 7.1 kg (15.7 lbs.)
Movable range	Height adjustable stand	Tilt : 40° Up, 0° Down Swivel : 35° Right, 35° Left Adjustable height : 82 mm (3.23 inch) Rotation : 90° (clockwise)
	FlexStand	Tilt : 30° Up, 0° Down Swivel : 172° Right, 172° Left Adjustable height : 225 mm (8.9 inch) (Tilt 0°: 157mm (6.2 inch)) Rotation : 90° (clockwise)
Environmental Conditions	Temperature	Operating: 0 °C - 35 °C (32 °F - 95 °F) Transportation/Storage: -20 °C - 60 °C (-4 °F - 140 °F)
	Humidity	Operating: 20% - 80% R.H. (no condensation) Transportation/Storage: 10% - 80% R.H. (no condensation)
	Pressure	Operating: 700 to 1,060 hPa Transportation/Storage: 200 to 1,060 hPa
USB	Standard	USB Specification Revision 2.0
	Port	Upstream port × 1, Downstream port × 2
	Communication Speed	480 Mbps (high), 12 Mbps (full), 1.5 Mbps (low)
	Supply current	Downstream: Max. 500mA/1 port

### Main default settings (factory settings)

Color Mode	Custom
PowerManager	On
Input Selection	Manual
Screen Size	Full
Auto EcoView	Off
Outline Enhancer	0
Menu Position	Center
Language	English

# Outside Dimensions

CG223W

Unit: mm (inch)

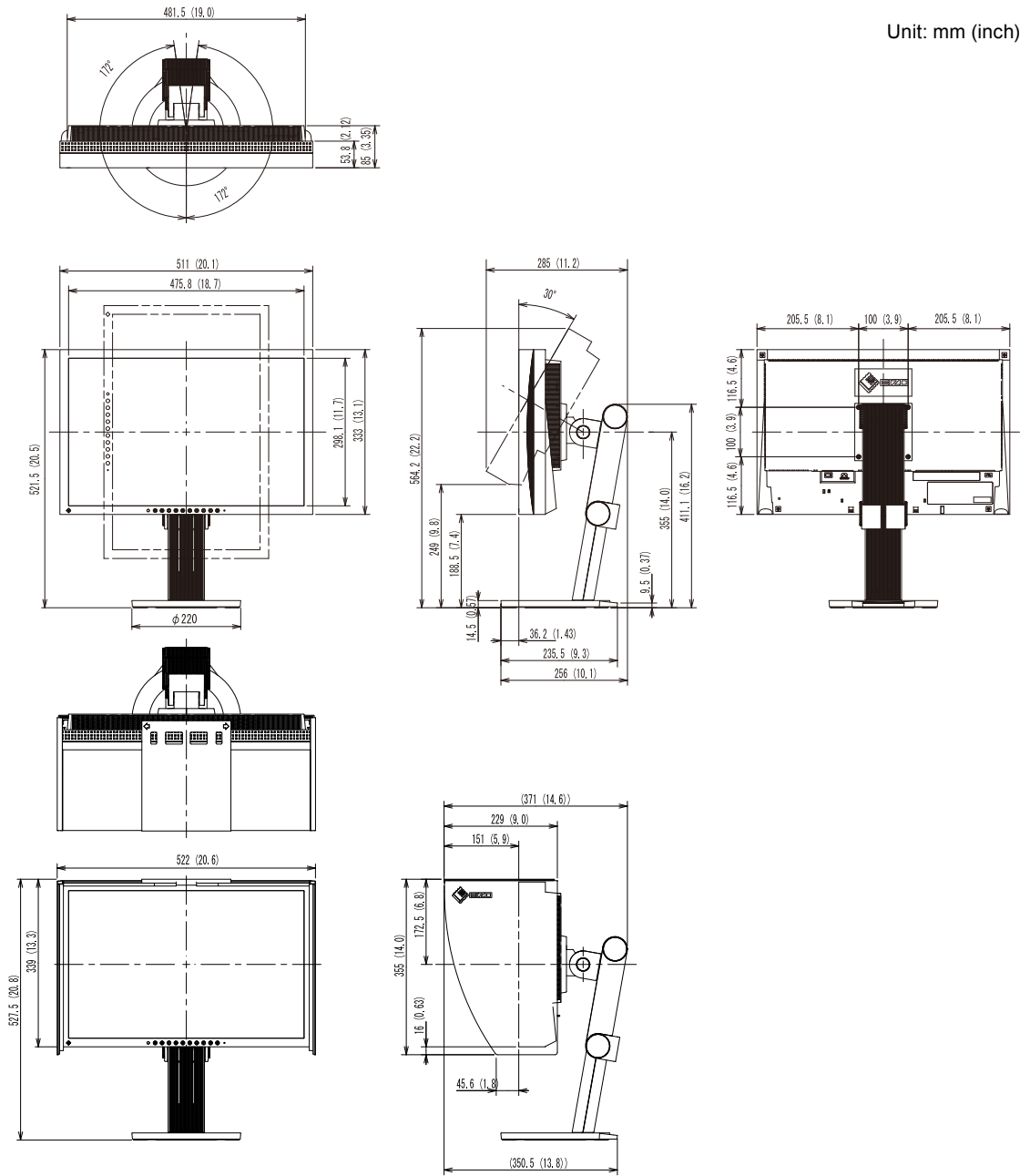

# Outside Dimensions

CG243W

- Height adjustable stand

Unit: mm (inch)

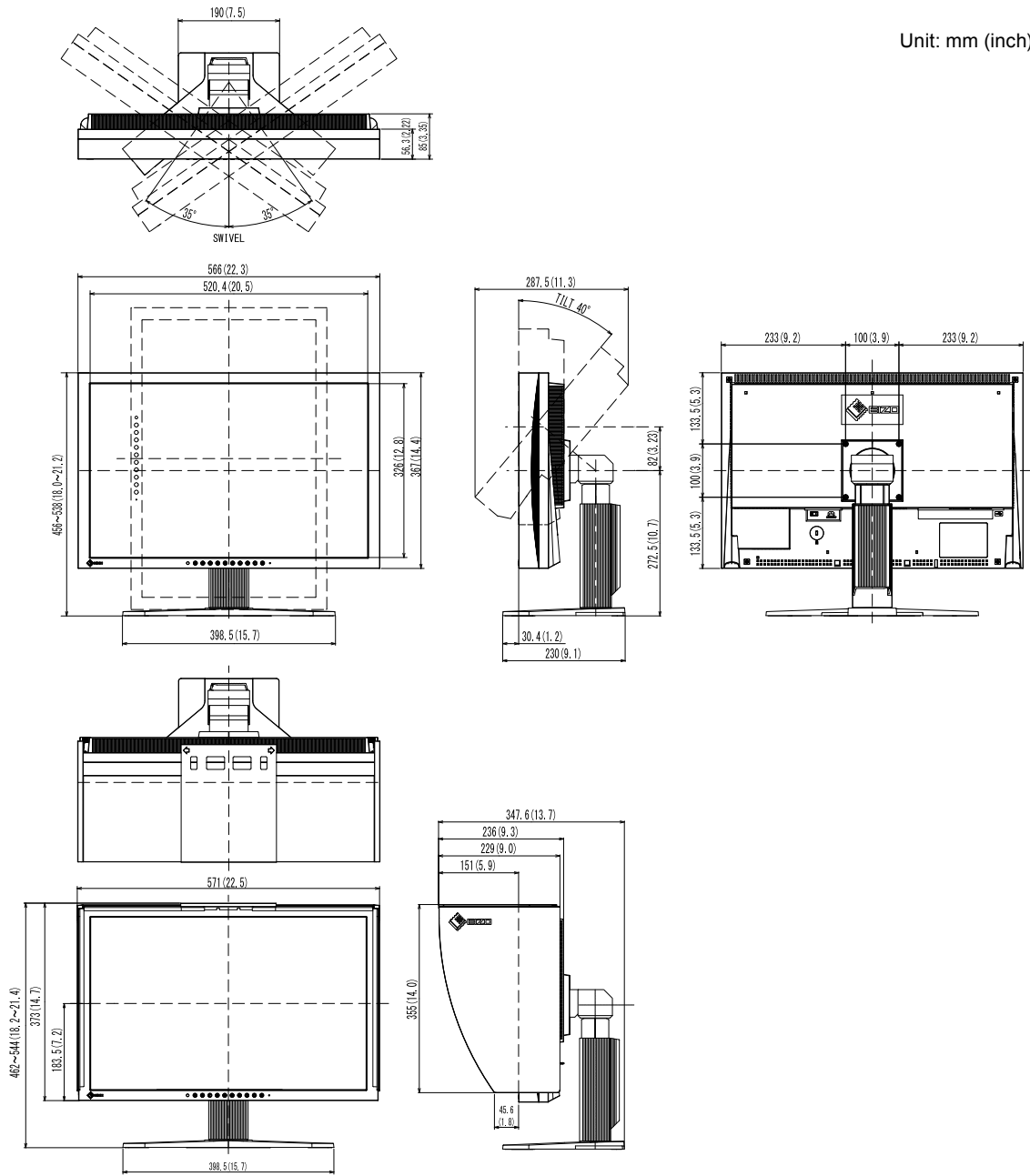

• FlexStand

Unit: mm (inch)

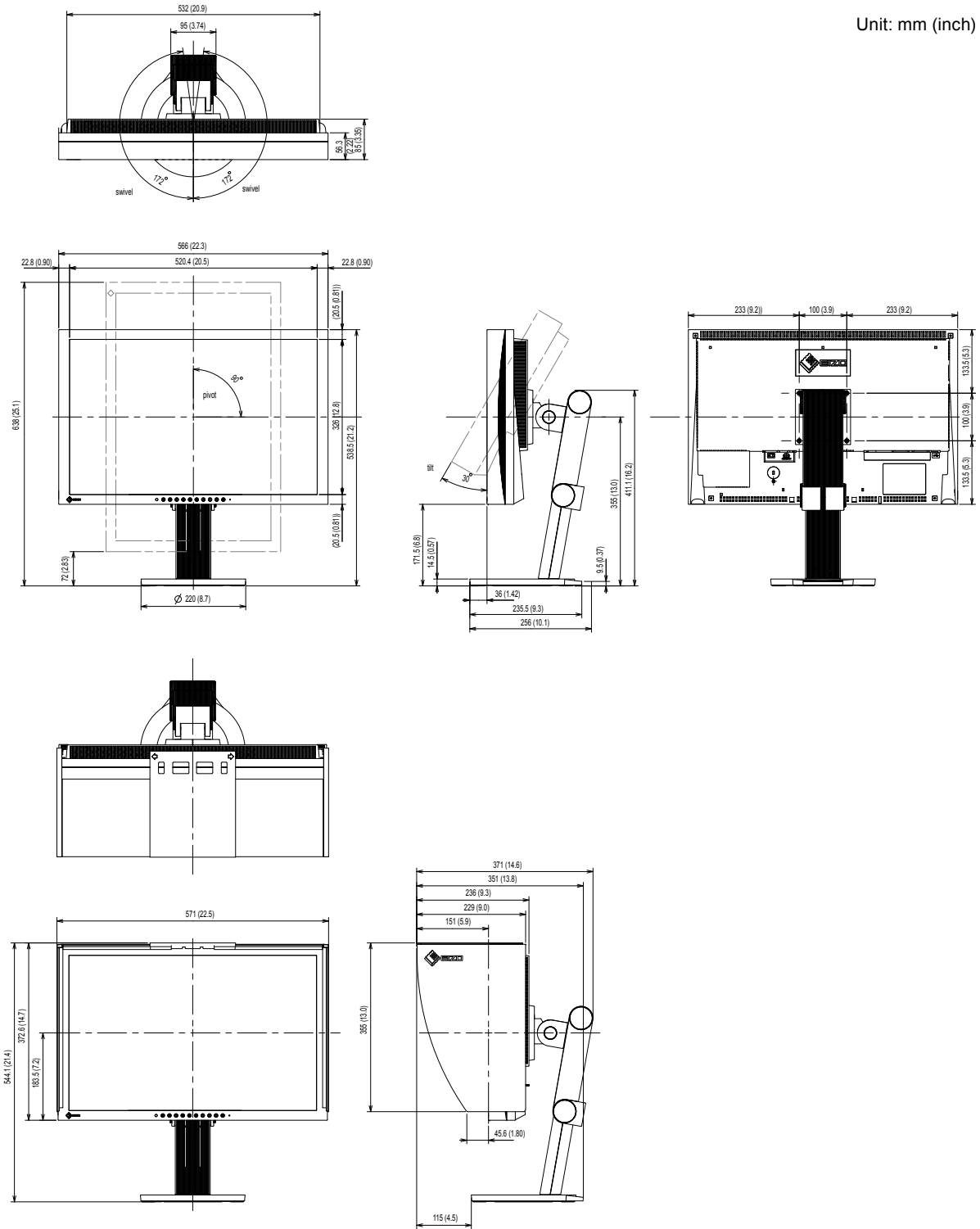

## Connector Pin Assignment

- DVI-I connector

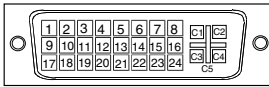

Pin No.	Signal	Pin No.	Signal	Pin No.	Signal
1	T.M.D.S. Data 2-	11	T.M.D.S. Data1/3 Shield	21	NC*
2	T.M.D.S. Data 2+	12	NC*	22	T.M.D.S. Clock shield
3	T.M.D.S. Data2/4 Shield	13	NC*	23	T.M.D.S. Clock+
4	NC*	14	+5V Power	24	T.M.D.S. Clock-
5	NC*	15	Ground (return for +5V, Hsync, and Vsync)	C1	Analog Red
6	DDC Clock (SCL)	16	Hot Plug Detect	C2	Analog Green
7	DDC Data (SDA)	17	T.M.D.S. Data0-	C3	Analog Blue
8	Analog Vertical Sync	18	T.M.D.S. Data0+	C4	Analog Horizontal Sync
9	T.M.D.S. Data1-	19	T.M.D.S. Data0/5 Shield	C5	Analog Ground(analog R,G,&B return)
10	T.M.D.S. Data1+	20	NC*		

(NC\*: No Connection)

- DisplayPort connector

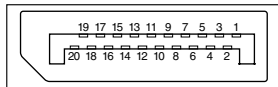

Pin No.	Signal	Pin No.	Signal	Pin No.	Signal
1	ML Lane3-	8	Ground	15	AUX CH+
2	Ground	9	ML Lane1+	16	Ground
3	ML Lane3+	10	ML Lane0-	17	AUX CH-
4	ML Lane2-	11	Ground	18	Hot Plug Detect
5	Ground	12	ML Lane0+	19	Return
6	ML Lane2+	13	CONFIG1	20	DP PWR
7	ML Lane1-	14	CONFIG2		

- USB port

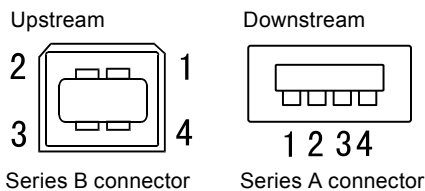

Contact No.	Signal	Remarks
1	VCC	Cable power
2	- Data	Serial data
3	+ Data	Serial data
4	Ground	Cable ground

## 6-6. Glossary

---

### **Clock**

The analog input monitor needs to reproduce a clock of the same frequency as the dot clock of the graphics system in use, when the analog input signal is converted to a digital signal for image display. This is called clock adjustment. If the clock pulse is not set correctly, some vertical bars appear on the screen.

### **DisplayPort**

DisplayPort is a next-generation digital AV interface that allows connection of the PC, audio, imaging devices, etc. to the monitor. One cable can transfer sound with images.

### **DVI (Digital Visual Interface)**

DVI is a digital interface standard. DVI allows direct transmission of the PC's digital data without loss. This adopts the TMDS transmission system and DVI connectors. There are two types of DVI connectors. One is a DVI-D connector for digital signal input only. The other is a DVI-I connector for both digital and analog signal inputs.

### **DVI DMPM (DVI Digital Monitor Power Management)**

DVI DMPM is a digital interface power-saving function. The "Monitor ON (operating mode)" and "Active Off (power-saving mode)" are indispensable for DVI DMPM as the monitor's power mode.

### **Gain**

This is used to adjust each color parameter for red, green and blue. An LCD monitor displays the color by the light passing through the panel color filter. Red, green and blue are the three primary colors. All the colors on the screen are displayed by combining these three colors. The color tone can be changed by adjusting the light intensity (volume) passing through each color's filter.

### **Gamma**

Generally, the monitor brightness varies nonlinearly with the input signal level, which is called "Gamma Characteristic". A small gamma value produces a low-contrast image, while a large gamma value produces a highcontrast image.

## **HDCP (High-bandwidth Digital Contents Protection)**

Digital signal coding system developed to copy-protect the digital contents, such as video, music, etc. This helps to transmit the digital contents safely by coding the digital contents sent via DVI terminal on the output side and decoding them on the input side. Any digital contents cannot be reproduced if both of the equipments on the output and input sides are not applicable to HDCP system.

## **Phase**

Phase means the sampling timing to convert the analog input signal to a digital signal. Phase adjustment is made to adjust the timing. It is recommended that phase adjustment be made after the clock is adjusted correctly.

## **Range Adjustment**

Range adjustment controls the signal output levels to display every color gradation. It is recommended that range adjustment be made before color adjustment.

## **Resolution**

The LCD panel consists of numerous pixels of specified size, which are illuminated to form images. This monitor consists of 1680(CG223W) / 1920(CG243W) horizontal pixels and 1050(CG223W) / 1200(CG243W) vertical pixels. At a resolution of 1680 x 1050(CG223W) / 1920 x 1200(CG243W) , all pixels are illuminated as a full screen (1:1).

## **sRGB (Standard RGB)**

"International Standard for Red, Green, and Blue color space" A color space was defined with the aim of the color matching between applications and hardware devices, such as monitors, scanners, printers and digital cameras. As a standard default space, sRGB allows Internet users to closely match colors.

## **Temperature**

Color temperature is a method to measure the white color tone, generally indicated in degrees Kelvin. The screen becomes reddish at a low temperature, and bluish at a high temperature, like the flame temperature.

5000K: Slightly reddish white (usually used in print industry)

6500K: White called daylight color (suited for web browsing)

9300K: Slightly bluish white (usually used for television)

## **TMDS (Transition Minimized Differential Signaling)**

A signal transmission system for digital interface.

## **VESA DPM (Video Electronics Standards Association - Display Power Management )**

VESA specifications achieve increased energy efficiency for computer monitors. This involves standardization of signals sent from the computer (graphics board). DPM defines the status of signals transmitted between the computer and monitor.

## 6-7. Preset Timing

The following table shows factory preset video timing (for analog signal only).

### Attention

- Display position may be deviated depending on the PC connected, which may require screen adjustment using Adjustment menu.
- If a signal other than those listed in the table is input, adjust the screen using the Adjustment menu. However, screen display may still be incorrect even after the adjustment.
- When interlace signals are used, the screen cannot be displayed correctly even after screen adjustment using the Adjustment menu.

Resolution	Applicable signal	Frequency			Polarity		CG223W	CG243W
		Dot clock : MHz	Horizontal : kHz	Vertical : Hz	Horizontal	Vertical		
640 × 480	VGA	25.18	31.47	59.94	Negative	Negative	√	√
720 × 400	VGA TEXT	28.32	31.47	70.09	Negative	Positive	√	√
800 × 600	VESA	40.00	37.88	60.32	Positive	Positive	√	√
1024 × 768	VESA	65.00	48.36	60.00	Negative	Negative	√	√
1024 × 768	VESA	75.00	56.48	70.07	Negative	Negative	√	—
1024 × 768	VESA	78.75	60.02	75.03	Positive	Positive	√	—
1024 × 768	VESA	94.50	68.68	85.00	Positive	Positive	√	—
1152 × 864	VESA	108.00	67.50	75.00	Positive	Positive	√	—
1280 × 960	VESA	108.00	60.00	60.00	Positive	Positive	√	√
1280 × 1024	VESA	108.00	63.98	60.02	Positive	Positive	√	√
1600 × 1200	VESA	161.99	75.00	60.00	Positive	Positive	—	√
1680 × 1050	VESA CVT	146.25	65.29	59.95	Negative	Positive	√	√
1680 × 1050	VESA CVT RB	119.00	64.67	59.88	Positive	Negative	√	—
1920 × 1200	VESA CVT RB	154.00	74.04	59.95	Positive	Negative	—	√





Congratulations!

The display you have just purchased carries the TCO'03 Displays label. This means that your display is designed, manufactured and tested according to some of the strictest quality and environmental requirements in the world. This makes for a high performance product, designed with the user in focus that also minimizes the Impact on our natural environment.

Some of the features of the TCO'03 Display requirements:

#### Ergonomics

- Good visual ergonomics and image quality in order to improve the working environment for the user and to reduce sight and strain problems. Important parameters are luminance, contrast, resolution, reflectance, colour rendition and image stability.

#### Energy

- Energy-saving mode after a certain time - beneficial both for the user and environment
- Electrical safety

#### Emissions

- Electromagnetic fields
- Noise emissions

#### Ecology

- The products must be prepared for recycling and the manufacturer must have a certified environmental management system such as EMAS or ISO 14000
- Restrictions on
  - chlorinated and brominated flame retardants and polymers
  - heavy metals such as cadmium, mercury and lead.

The requirements included in this label have been developed by TCO Development in co-operation with scientists, experts, users as well as manufacturers all over the world. Since the end of the 1980s TCO has been involved in influencing the development of IT equipment in a more user-friendly direction. Our labeling system with displays in 1992 and is now requested by users and IT-manufacturers all over the world.

**For more information, please visit  
[www.tcodevelopment.com](http://www.tcodevelopment.com)**

For U.S.A. , Canada, etc. (rated 100-120 Vac) Only

**FCC Declaration of Conformity**

**We, the Responsible Party**

EIZO Inc.

5710 Warland Drive, Cypress, CA 90630

Phone: (562) 431-5011

**declare that the product**

Trade name: EIZO

Model: ColorEdge CG223W / CG243W

**is in conformity with Part 15 of the FCC Rules. Operation of this product is subject to the following two conditions: (1) this device may not cause harmful interference, and (2) this device must accept any interference received, including interference that may cause undesired operation.**

This equipment has been tested and found to comply with the limits for a Class B digital device, pursuant to Part 15 of the FCC Rules. These limits are designed to provide reasonable protection against harmful interference in a residential installation. This equipment generates, uses, and can radiate radio frequency energy and, if not installed and used in accordance with the instructions, may cause harmful interference to radio communications. However, there is no guarantee that interference will not occur in a particular installation. If this equipment does cause harmful interference to radio or television reception, which can be determined by turning the equipment off and on, the user is encouraged to try to correct the interference by one or more of the following measures.

- \* Reorient or relocate the receiving antenna.
- \* Increase the separation between the equipment and receiver.
- \* Connect the equipment into an outlet on a circuit different from that to which the receiver is connected.
- \* Consult the dealer or an experienced radio/TV technician for help.

Changes or modifications not expressly approved by the party responsible for compliance could void the user's authority to operate the equipment.

**Note**

Use the attached specified cable below or EIZO signal cable with this monitor so as to keep interference within the limits of a Class B digital device.

- AC Cord
- Shielded Signal Cable (Enclosed)

**Canadian Notice**

This Class B digital apparatus complies with Canadian ICES-003.

Cet appareil numérique de la classe B est conforme à la norme NMB-003 du Canada.

### **Hinweise zur Auswahl des richtigen Schwenkarms für Ihren Monitor**

Dieser Monitor ist für Bildschirmarbeitsplätze vorgesehen. Wenn nicht der zum Standardzubehör gehörige Schwenkarm verwendet wird, muss statt dessen ein geeigneter anderer Schwenkarm installiert werden. Bei der Auswahl des Schwenkarms sind die nachstehenden Hinweise zu berücksichtigen:

Der Standfuß muß den nachfolgenden Anforderungen entsprechen:

- a) Der Standfuß muß eine ausreichende mechanische Stabilität zur Aufnahme des Gewichtes vom Bildschirmgerät und des spezifizierten Zubehörs besitzen. Das Gewicht des Bildschirmgerätes und des Zubehörs sind in der zugehörigen Bedienungsanleitung angegeben.
- b) Die Befestigung des Standfusses muß derart erfolgen, daß die oberste Zeile der Bildschirmanzeige nicht höher als die Augenhöhe eines Benutzers in sitzender Position ist.
- c) Im Fall eines stehenden Benutzers muß die Befestigung des Bildschirmgerätes derart erfolgen, daß die Höhe der Bildschirmmitte über dem Boden zwischen 135 – 150 cm beträgt.
- d) Der Standfuß muß die Möglichkeit zur Neigung des Bildschirmgerätes besitzen (max. vorwärts: 5°, min. nach hinten  $\geq 5^\circ$ ).
- e) Der Standfuß muß die Möglichkeit zur Drehung des Bildschirmgerätes besitzen (max.  $\pm 180^\circ$ ). Der maximale Kraftaufwand dafür muß weniger als 100 N betragen.
- f) Der Standfuß muß in der Stellung verharren, in die er manuell bewegt wurde.
- g) Der Glanzgrad des Standfusses muß weniger als 20 Glanzeinheiten betragen (seidenmatt).
- h) Der Standfuß mit Bildschirmgerät muß bei einer Neigung von bis zu 10° aus der normalen aufrechten Position kippstabil sein.

### **Hinweis zur Ergonomie :**

Dieser Monitor erfüllt die Anforderungen an die Ergonomie nach EK1-ITB2000 mit dem Videosignal, 1680× 1050 (CG223W) / 1920× 1200 (CG243W), Digital Eingang und mindestens 60,0 Hz Bildwiederholfrequenz, non interlaced. Weiterhin wird aus ergonomischen Gründen empfohlen, die Grundfarbe Blau nicht auf dunklem Untergrund zu verwenden (schlechte Erkennbarkeit, Augenbelastung bei zu geringem Zeichenkontrast.)

„Maschinenlärminformations-Verordnung 3. GPSGV:

Der höchste Schalldruckpegel beträgt 70 dB(A) oder weniger gemäss EN ISO 7779“

## 关于电子信息产品污染控制标识



本标识根据「电子信息产品污染控制管理办法」，适用于在中华人民共和国销售的电子信息产品。标识中央的数字为环保使用期限的年数。只要您遵守该产品相关的安全及使用注意事项，在自制造日起算的年限内，不会产生对环境污染或人体及财产的影响。上述标识粘贴在机器背面。

### • 有毒有害物质或元素的名称及含量

部件名称	有毒有害物质或元素					
	铅 (Pb)	汞 (Hg)	镉 (Cd)	六价铬 (Cr (VI))	多溴联苯 (PBB)	多溴二苯醚 (PBDE)
印刷电路板	×	○	○	○	○	○
机箱	○	○	○	○	○	○
液晶显示器	×	×	○	○	○	○
其他	×	○	○	○	○	○

○：表示该有毒有害物质在该部件所有均质材料中的含量均在 SJ/T 11363-2006 规定的限量要求以下。  
 ×：表示该有毒有害物质至少在该部件的某一均质材料中的含量超出 SJ/T 11363-2006 规定的限量要求。  
 （企业可在此处，根据实际情况对上表中打“×”的技术原因进行进一步说明）

