

Installationsvejledning

ColorEdge® CG2730

Farvestyring af LCD-farveskærm

Vigtigt















Læs PRECAUTIONS (FORHOLDSREGLER), denne installationsvejledning og brugervejledningen på cd-rommen omhyggeligt for at blive fortrolig med enheden og bruge den sikkert og effektivt. Gem denne vejledning til senere brug.

Se vores websted for de seneste produktoplysninger samt brugervejledningen.

<http://www.eizoglobal.com>



1. Pakkens indhold

 <ul style="list-style-type: none">• Skærm	 <ul style="list-style-type: none">• Setup Guide (Installationsvejledning)	 <ul style="list-style-type: none">• PRECAUTIONS (FORHOLDSREGLER)
 <ul style="list-style-type: none">• Adjustment Certificate (justeringscertifikat)	 <ul style="list-style-type: none">• EIZO LCD Utility Disk	 <ul style="list-style-type: none">• ColorNavigator Quick Reference (ColorNavigator kvikguide)
 <ul style="list-style-type: none">• DD200DL DVI Dual Link-kabel	 <ul style="list-style-type: none">• PM200 DisplayPort-kabel	
 <ul style="list-style-type: none">• UU200SS (USB 3.0) USB-kabel	 <ul style="list-style-type: none">• Netledning	
 <ul style="list-style-type: none">• Monteringsskruer	 <ul style="list-style-type: none">• ScreenCleaner (Rengørings sæt)	
 <ul style="list-style-type: none">• Skærmhætte	 <ul style="list-style-type: none">• Brugervejledning til skærmhætte	

2. Forbindelser

1.

2.

3.

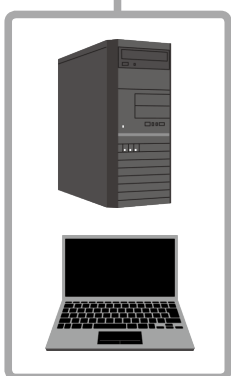
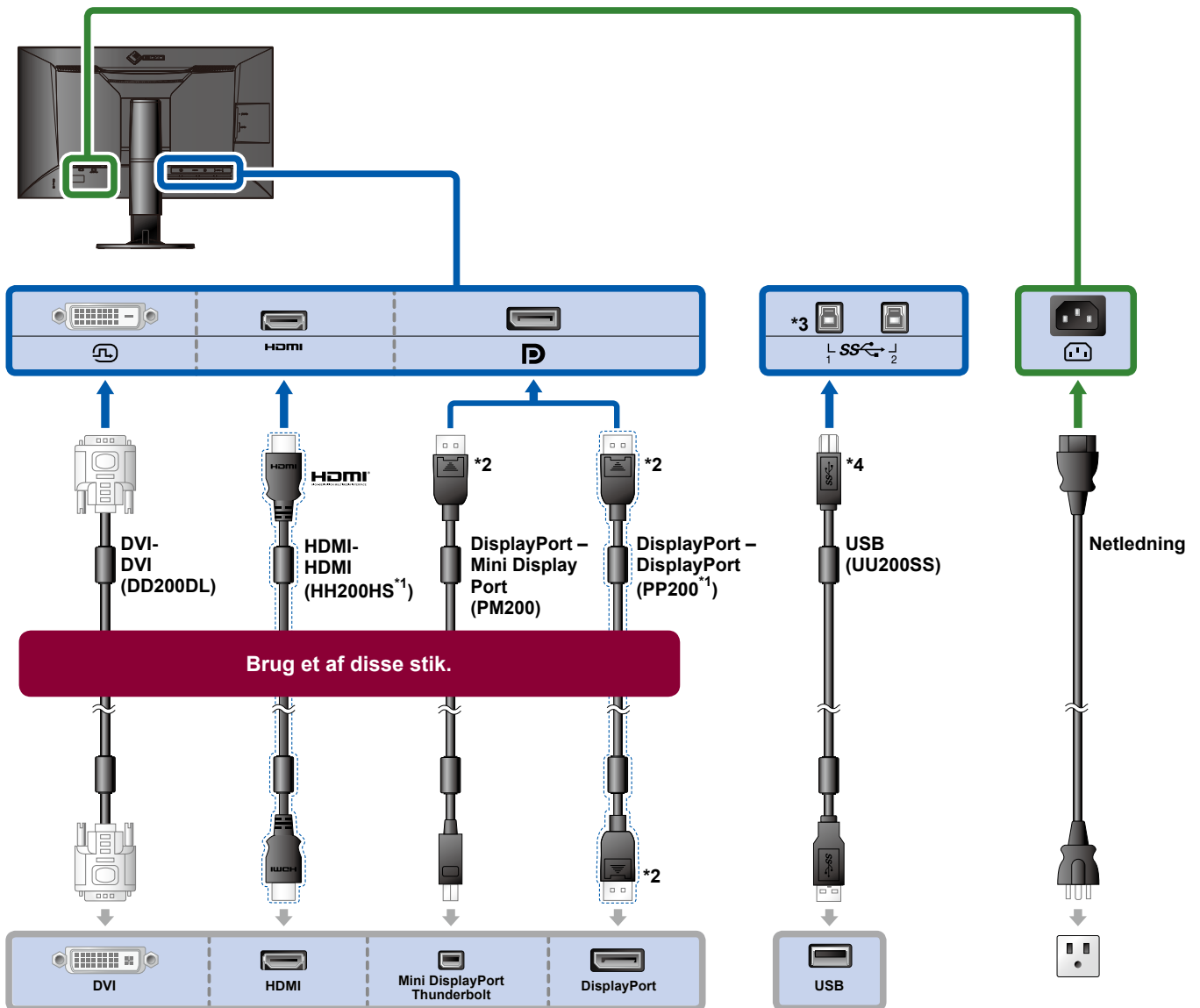

*1 ekstraudstyr

*2 Fjernelse

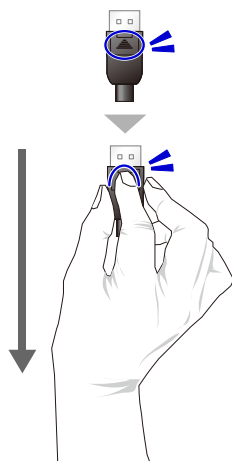

*3 Brug port 1. USB-upstream-port 2 er deaktiveret som standard. Se brugervejledningen til skærmen, hvis du vil ændre indstillingerne.

*4 Sørg altid for, at dette kabel er tilsluttet ved brug af ColorNavigator 6.

4.

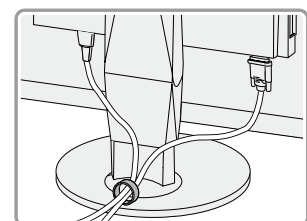
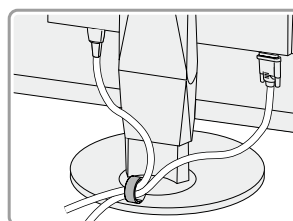

Brug kabelholderen bag på foden for at holde kablerne pænt sammen.

3. Justering af vinkel og højde

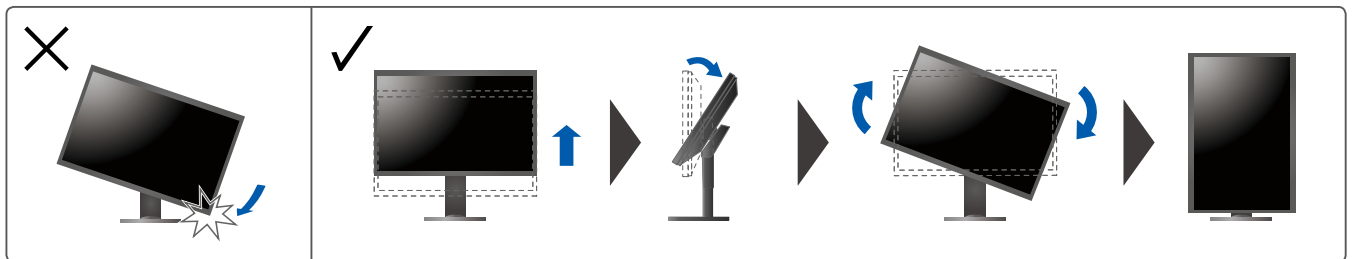
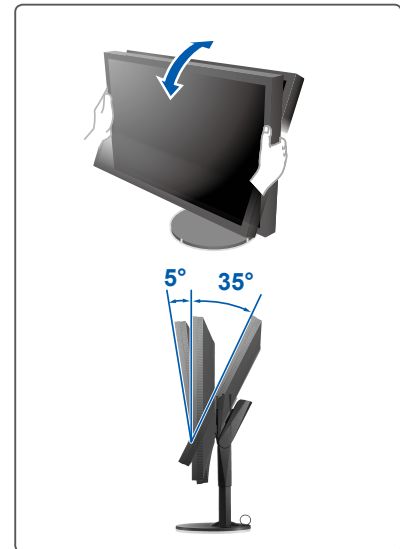
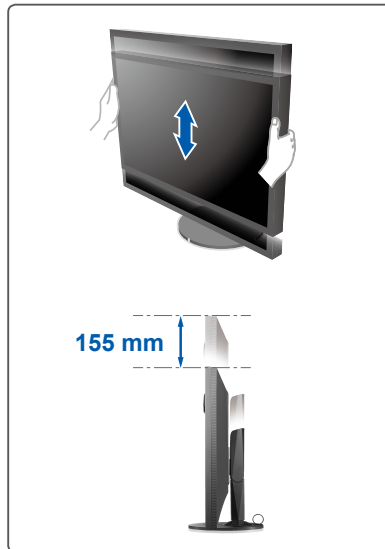
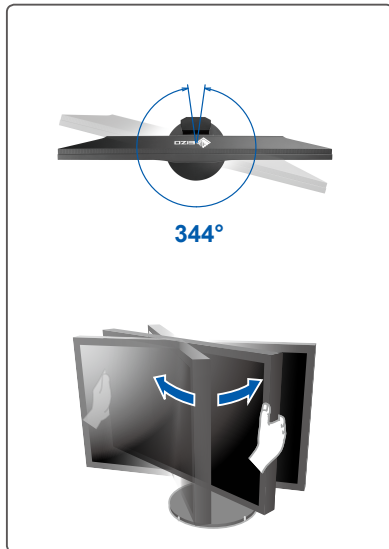

4. Skærm

1. Hovedafbryder

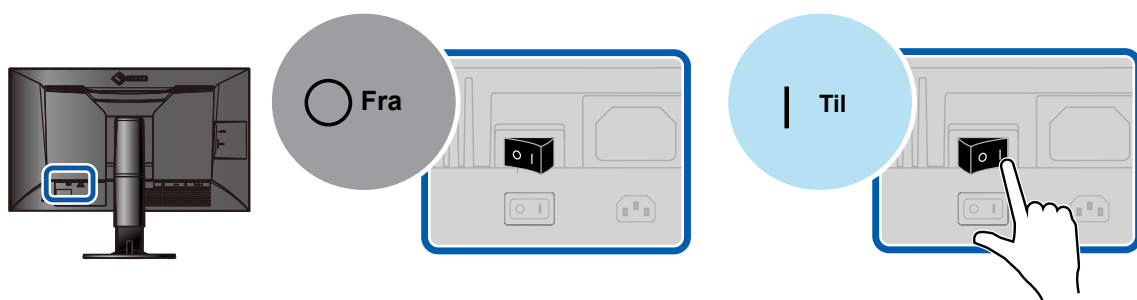

2. Tænd/sluk-knap

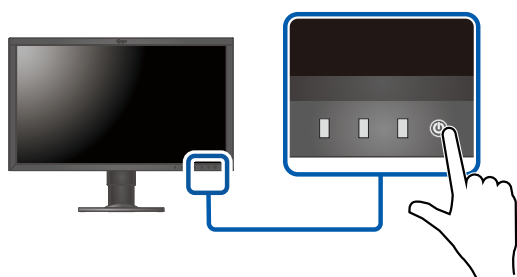

3. Anbefalet opløsning



5. Sprog

1.

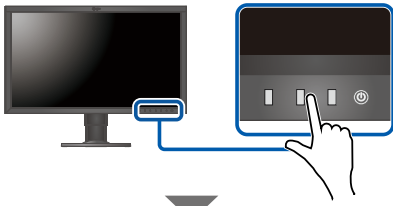

2.

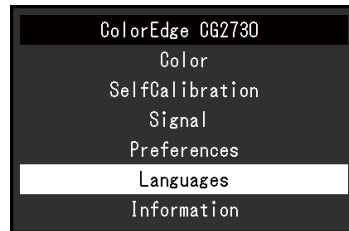
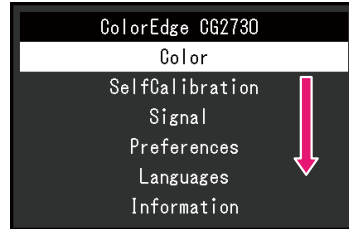
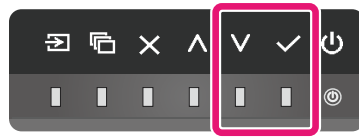

3.

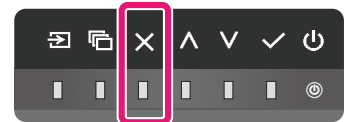
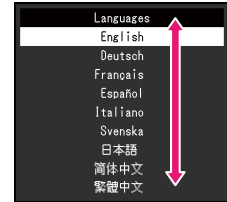
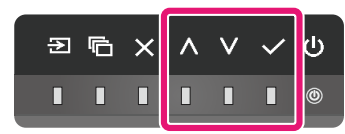

6. Hætte



- Oplysninger om installation finder du i brugervejledningen til skærmhætten.

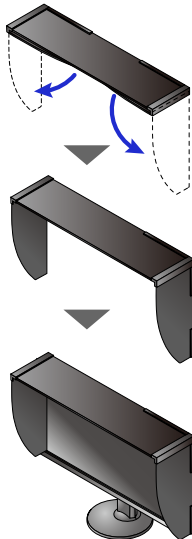

SelfCalibration

Giver dig mulighed for at foretage periodisk kalibrering.

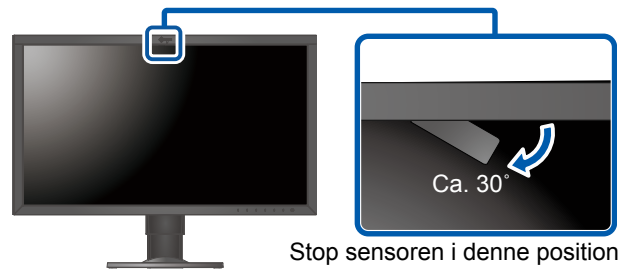

Stop sensoren i denne position.



- Se brugervejledningen til skærmen på cd-rom'en for at få oplysninger om SelfCalibration.

ColorNavigator



- Instruktions for brugen finder du i "Quick Reference" (kvikguiden) og brugervejledningen til ColorNavigator (gemt på cd-rom'en).

Problem med manglende billede

Tryk på  på skærmen for at slå strømmen til.

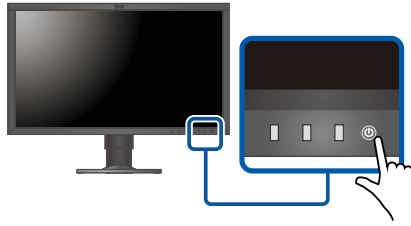

 lyser hvid.

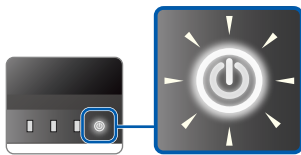

 lyser ikke.

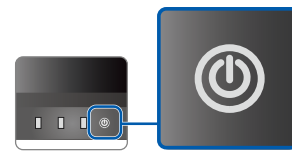

Slå skærmens strøm til.

- Tænd for hovedkontakten bag på skærmen.
- Kontroller, at ledningen er sat korrekt i.

En besked vises på skærmen.

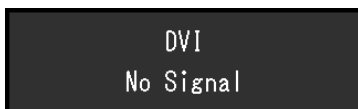

Indlæs et signal.

- Tryk på  for at skifte til indgangsterminalen, hvor signalkablet er tilsluttet.*1
- Kontroller, at signalkablet er tilsluttet korrekt.
- Pc'en kan være i dvaletilstand. Betjen musen eller tastaturet.
- Kontroller, at pc'en er tændt.

Hvis ovenstående trin ikke løser problemet, kan du prøve at genstarte pc'en.

- Tænd for hovedkontakten bag på skærmen.
- Genstart pc'en.

En besked vises på skærmen.



Det korrekte signal er ikke indlæst fra pc'en.

- Genstart pc'en.
- Pc'ens grafiske driver fungerer muligvis ikke korrekt. Kontakt computerforhandleren eller producenten for flere oplysninger.

*1

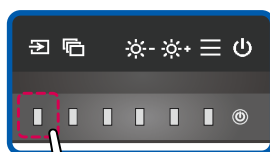

Ingen besked vises på skærmen.

- Forøg "Brightness" (Lysstyrke).^{*2}
- Genstart pc'en.

*2

