

Instructions for Use

■ User's Manual

RadiForce®
RX240
RX340
RX340-AR

Color LCD Monitor

Important

Please read PRECAUTIONS, this User's Manual, and Setup Manual (separate volume) carefully to familiarize yourself with safe and effective usage.

-
- Please refer to the Setup Manual for basic information ranging from connection of the monitor to a PC to using the monitor.
 - The latest User's Manual is available for download from our web site:
<http://www.eizoglobal.com>
-



This product has been adjusted specifically for use in the region to which it was originally shipped. If operated outside this region, the product may not perform as stated in the specifications.

No part of this manual may be reproduced, stored in a retrieval system, or transmitted, in any form or by any means, electronic, mechanical, or otherwise, without the prior written permission of EIZO Corporation.

EIZO Corporation is under no obligation to hold any submitted material or information confidential unless prior arrangements are made pursuant to EIZO Corporation's receipt of said information. Although every effort has been made to ensure that this manual provides up-to-date information, please note that EIZO monitor specifications are subject to change without notice.

Notice for this monitor

This product is intended to be used in displaying and viewing digital images for diagnosis of X-ray or MRI, etc. by trained medical practitioners. It does not support the display of mammography images for diagnosis.

Caution: Federal law (USA) restricts this device to sale by or on the order of a physician.

This product has been adjusted specifically for use in the region to which it was originally shipped. If the product is used outside the region, it may not operate as specified in the specifications.

This product may not be covered by warranty for uses other than those described in this manual.

The specifications noted in this manual are only applicable when the following are used:

- Power cords provided with the product
 - Signal cables specified by us
-

Only use optional products manufactured or specified by us with this product.

As it takes about 30 minutes for the performance of electrical parts to stabilize, adjust the monitor 30 minutes or more after the monitor power has been turned on or the monitor has recovered from the power saving mode.

Monitors should be set to a lower brightness to reduce changes in luminosity caused by long-term use and maintain a stable display.

When the screen image is changed after displaying the same image for extended periods of time, an afterimage may appear. Use the screen saver or power save function to avoid displaying the same image for extended periods of time.

Periodic cleaning is recommended to keep the monitor looking new and to prolong its operation lifetime (refer to [“Cleaning” \(page 4\)](#)).

The screen may have defective pixels or a small number of light dots on the screen. This is due to the characteristics of the panel itself, and is not a malfunction of the product.

The backlight of the LCD panel has a fixed lifetime. When the screen becomes dark or begins to flicker, please contact your dealer.

Do not press on the panel or edge of the frame strongly, as this may result in display malfunctions, such as interference patterns, etc. If pressure is continually applied to the panel, it may deteriorate or damage your panel. (If the pressure marks remain on the panel, leave the monitor with a black or white screen. The symptom may disappear.)

Do not scratch or press on the panel with any sharp objects, as this may result in damage to the panel. Do not attempt to brush with tissues as this may scratch the panel.

When the monitor is cold and brought into a room or the room temperature goes up quickly, dew condensation may occur on the interior and exterior surfaces of the monitor. In that case, do not turn the monitor on. Instead wait until the dew condensation disappears, otherwise it may cause some damage to the monitor.

Cleaning

Attention

- Chemicals such as alcohol and antiseptic solution may cause gloss variation, tarnishing, and fading of the cabinet or panel, and also quality deterioration of the image.
- Never use any thinner, benzene, wax, and abrasive cleaner, which may damage the cabinet or panel.

Note

- The optional ScreenCleaner is recommended for cleaning the cabinet and panel surface.

If necessary, the stains on the cabinet and panel surface can be removed by moistening part of a soft cloth with water.

To use the monitor comfortably

- An excessively dark or bright screen may affect your eyes. Adjust the brightness of the monitor according to the environmental conditions.
- Staring at the monitor for a long time tires your eyes. Take a 10-minute rest every hour.

CONTENTS

Notice for this monitor	3	3-6. Locking Buttons	21
Cleaning	4	3-7. Enabling/Disabling DDC Communication ...	21
To use the monitor comfortably	4	3-8. Enabling/Disabling DC5V Output	21
CONTENTS	5	3-9. Return To Default Setting	22
Chapter 1 Introduction	7	● To reset the color adjustments	22
1-1. Features	7	● To reset all settings	22
1-2. EIZO LCD Utility Disk	8	Chapter 4 Controlling Monitor Quality	23
● Disk contents and software overview	8	4-1. Executing Calibration	23
● To use RadiCS LE/ScreenManager Pro for Medical.....	8	● Executing SelfCalibration.....	23
1-3. Basic Operations and Functions	9	● Viewing SelfCalibration result	23
● Basic Adjustment menu operations	9	4-2. Checking Grayscale	24
● Functions.....	10	● Executing Grayscale Check.....	24
Chapter 2 Adjusting Screens	11	● Viewing Grayscale Check result	24
2-1. Compatible Resolutions	11	4-3. Acquiring Life Prediction Data	24
2-2. Setting the Resolution	11	4-4. Setting On/Off for Warning and QC History	25
● Windows 8 / Windows 7	11	Chapter 5 Power Saving Functions	26
● Windows Vista.....	11	5-1. Setting Power Save	26
● Windows XP	11	5-2. Setting Power Indicator	26
● Mac OS X	11	5-3. Setting the power saving mode when a person leaves the monitor	27
2-3. Adjusting Color	12	Chapter 6 Troubleshooting	28
● To select the display mode (CAL Switch mode)	12	6-1. No picture	28
● To perform advanced adjustments	12	6-2. Imaging problems	29
● Adjustable settings in each mode	13	6-3. Other problems	30
● To adjust brightness	13	● Error Code Table	31
● To adjust contrast.....	14	Chapter 7 Reference	32
● To adjust color temperature	14	7-1. How to Attach the Arm	32
● To adjust gamma	15	7-2. Connecting Multiple PCs	33
● To adjust hue	15	● To switch among input signals	33
● To adjust saturation.....	15	● To set input signal selection	34
● To adjust gain	16	7-3. Making Use of USB (Universal Serial Bus)	35
● To set the mode in the monochrome display area	16	● Required system environment	35
● To set the mode in the base display area	17	● Connection procedure (Setup of USB function).....	35
● To set the detection type in the image display area	17	7-4. Displaying Monitor Information	36
● To set the highlight area in the image display area	18	● Displaying signal information	36
2-4. Selecting Screen Size	18	● Displaying Monitor Information	36
Chapter 3 Setting Monitor	19	7-5. Specifications	37
3-1. Setting Orientation	19	7-6. Glossary	43
3-2. Enabling/Disabling Mode Selection	19	Appendix	45
3-3. Setting Language	20	Trademark	45
3-4. Setting Adjustment Menu Display	20	License	45
● Changing Adjustment Menu Display Position ...	20	Medical Standards	46
3-5. Setting the EIZO Logo Display	20	EMC Information (RX340).....	47

FCC Declaration of Conformity 52
LIMITED WARRANTY 53
Recycling Information61

Chapter 1 Introduction

Thank you very much for choosing an EIZO color LCD monitor.

1-1. Features

- 21.3 inches (RX240)
- 21.2 inches (RX340/RX340-AR)
- Applicable to the resolution of 2M pixels (Portrait : 1200 × 1600 dots (H × V)) (RX240)
- Applicable to the resolution of 3M pixels (Portrait : 1536 × 2048 dots (H × V)) (RX340/RX340-AR)
- Uses high-contrast panel
Enables the display of sharp images.
 - 1200 : 1 (RX240/RX340-AR)
 - 1400 : 1 (RX340)
- Applicable to DisplayPort (applicable to 8 bit or 10 bit, not applicable to audio signals)
- The Hybrid Gamma function automatically identifies the display area for the monochrome and color images on the same screen, and displays each set status.
 - *1 The identification may fail depending on the displayed image. The software to be used needs to be verified. For validation, see [“To set the highlight area in the image display area” \(page 18\)](#).
- The RadiCS SelfQC function and the built-in Integrated Front Sensor allow the user to perform the calibration and Grayscale Check for the monitor independently.
See [“Chapter 4 Controlling Monitor Quality” \(page 23\)](#)
 - *2 When a panel protector (RP-902/RP-903) is installed, the Integrated Front Sensor cannot be used.
- The quality control software “RadiCS LE (for Windows)” used to calibrate the monitor and to manage the history is included
See [“1-2. EIZO LCD Utility Disk” \(page 8\)](#)
- The software “ScreenManager Pro for Medical” to adjust the screen using the mouse and keyboard is included
See [“1-2. EIZO LCD Utility Disk” \(page 8\)](#)
- CAL Switch function for selecting an optimal calibration mode
See [“To select the display mode \(CAL Switch mode\)” \(page 12\)](#)
- Selectable DICOM ([page 43](#)) Part 14 complied screen.
- Frame Synchronous mode supported (29.5 to 30.5 Hz (RX340/RX340-AR), 59 to 61 Hz)
- Power saving function
This product is equipped with power saving function.
 - Power Consumption when main power switch is Off: 0 W
Equipped with main power switch.
Turning off the main power switch completely shuts off power supply to the monitor while the monitor is not used.
 - Presence Sensor
The sensor on the front side of the monitor detects the movement of a person. When a person moves away from the monitor, it shifts to the power saving mode automatically and does not display the images on the screen. Therefore, the function reduces the power consumption.
See [“5-3. Setting the power saving mode when a person leaves the monitor” \(page 27\)](#)

- Long service life LED backlight LCD panel
- Built-in ambient light sensor
Built-in ambient light sensor measures the environmental illuminance in lux. Depending on the environment, the sensor sometimes indicates different values from those measured by a stand-alone illuminance meter.
The usage of this sensor requires the quality control software “RadiCS/RadiCS LE” and the measurement is always triggered by the user’s operation in the corresponding menu.
For further details about the measured value and how to execute the measurement, refer to the RadiCS/RadiCS LE User’s Manual (on the CD-ROM).
- HDCP (High-bandwidth Digital Content Protection) (DisplayPort only)

Attention

- Storing or using the monitor at a temperature of under 30°C and a humidity of under 70% is recommended, or it may affect the measurement accuracy of the built-in sensor. Avoid storing or using the sensor where it may be exposed to direct sunlight.
-

1-2. EIZO LCD Utility Disk

An “EIZO LCD Utility Disk” (CD-ROM) is supplied with this product. The following table shows the disk contents and the overview of the software programs.

● Disk contents and software overview

The disk includes application software programs for adjustment, and User’s Manual. Refer to Readme.txt file on the disk for software startup procedures or file access procedures.

Contents	Overview
Readme.txt file	
RadiCS LE (for Windows)	Quality control software for calibrating the monitor and managing the calibration history.
ScreenManager Pro for Medical (for Windows)	Software for adjusting the screen using the mouse and keyboard.
User’s Manual of this monitor (PDF file)	

● To use RadiCS LE/ScreenManager Pro for Medical

For the installation and use of “RadiCS LE/ScreenManager Pro for Medical”, refer to the respective User’s Manual on the disk.

When using this software, you will need to connect a PC to the monitor with the supplied USB cable. For more information, see [“7-3. Making Use of USB \(Universal Serial Bus\)” \(page 35\)](#).

1-3. Basic Operations and Functions

● Basic Adjustment menu operations

1. Displaying Adjustment Menu

1. Press ENTER. The Adjustment menu appears.

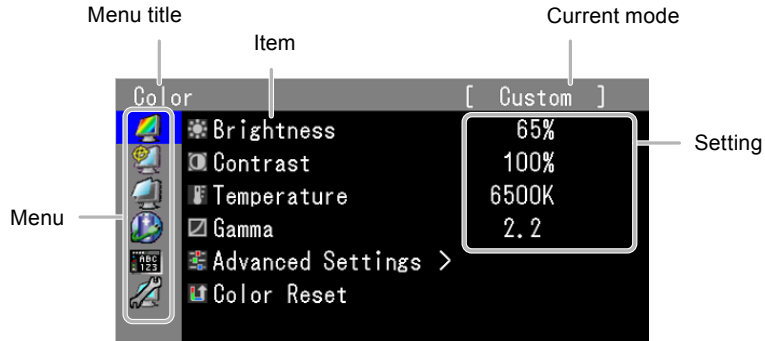

2. Adjusting/Setting

1. Choose a menu to adjust/set with ▲,▼, and then press ENTER.

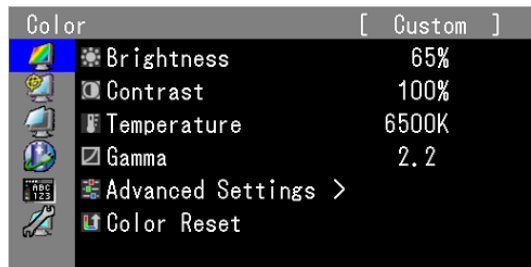

2. Choose an item to adjust/set with ▲,▼, and then press ENTER.

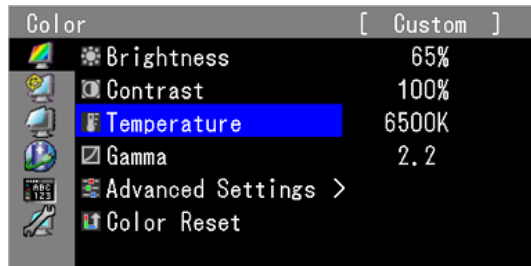

3. Adjust/set the selected item with ▲,▼, and then press ENTER.

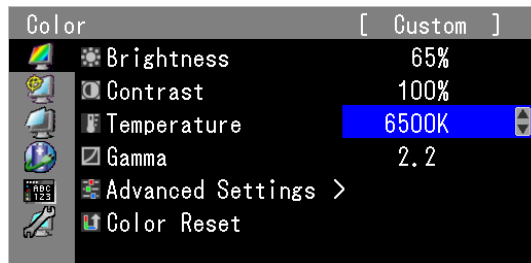





































3. Quit

1. Press RETURN a few times. The Adjustment menu finishes.

● Functions

The following table shows all the Adjustment menu's adjustment and setting menus.

Main Menu	Item	Reference	
Color 	 Brightness	"2-3. Adjusting Color" (page 12)	
	 Contrast		
	 Temperature		
	 Gamma		
	 Advanced Settings		 Hue
			 Saturation
			 Gain
	 Gray Area		
	 Color Area		
	 Base Area		
	 Hybrid Assignment		
 Highlight Area			
 Color Reset	"3-9. Return To Default Setting" (page 22)		
RadiCS SelfQC 	 SelfCalibration	"4-1. Executing Calibration" (page 23)	
	 Grayscale Check	"4-2. Checking Grayscale" (page 24)	
	 LEA	"4-3. Acquiring Life Prediction Data" (page 24)	
	 Settings	"4-4. Setting On/Off for Warning and QC History" (page 25)	
Screen 	 Screen Size	"2-4. Selecting Screen Size" (page 18)	
Power Manager 	 Power Save	"5-1. Setting Power Save" (page 26)	
	 Presence Sensor	"5-3. Setting the power saving mode when a person leaves the monitor" (page 27)	
	 Power Indicator	"5-2. Setting Power Indicator" (page 26)	
Menu Settings 	 Language	"3-3. Setting Language" (page 20)	
	 Menu Position	"3-4. Setting Adjustment Menu Display" (page 20)	
Tools 	 Input	"To switch among input signals" (page 33)	
	 Input Selection	"To set input signal selection" (page 34)	
	 Mode Preset	"3-2. Enabling/Disabling Mode Selection" (page 19)	
	 Signal Info	"7-4. Displaying Monitor Information" (page 36)	
	 Monitor Info		
	 All Reset	"3-9. Return To Default Setting" (page 22)	

* The adjustment/settings available on the "Color" menu depend on the selected mode. (See "2-3. Adjusting Color" (page 12))

Chapter 2 Adjusting Screens

2-1. Compatible Resolutions

For details on compatible resolutions, refer to “Compatible Resolutions” in the Setup Manual.

2-2. Setting the Resolution

● Windows 8 / Windows 7

1. For Windows 8, click the “Desktop” tile on the Start Screen to display the desktop.
2. Right-click the mouse anywhere on the desktop except for icons.
3. From the displayed menu, click “Screen resolution”.
4. On the “Screen Resolution” dialog box, select the monitor.
5. Click “Resolution” to select the desired resolution.
6. Click the “OK” button.
7. When a confirmation dialog box is displayed, click “Keep changes”.

● Windows Vista

1. Right-click the mouse anywhere on the desktop except for icons.
2. From the displayed menu, click “Personalize”.
3. On the “Personalization” window, click “Display Settings”.
4. On the “Display Settings” dialog box, select the “Monitor” tab and select desired resolution in the “Resolution” field.
5. Click the “OK” button.
6. When a confirmation dialog box is displayed, click “Yes”.

● Windows XP

1. Right-click the mouse anywhere on the desktop except for icons.
2. From the displayed menu, click “Properties”.
3. When the “Display Properties” dialog box is displayed, click the “Settings” tab and select desired resolution for “Screen resolution” under “Display”.
4. Click the “OK” button to close the dialog box.

● Mac OS X

1. Select “System Preferences” from the Apple menu.
2. When the “System Preferences” dialog box is displayed, click “Displays” for “Hardware”.
3. On the displayed dialog box, select the “Display” tab and select desired resolution in the “Resolutions” field.
4. Your selection will be reflected immediately. When you are satisfied with the selected resolution, close the window.

2-3. Adjusting Color

● To select the display mode (CAL Switch mode)

This function allows easy selection of a desired mode according to monitor application.

Display Modes

Mode	Purpose
1-DICOM	Available to display in DICOM mode.
2-Custom	Select one of these user modes to define a desired set of parameter settings.
3-CAL1	Displays the screen adjusted by calibration software.
4-CAL2	
5-CAL3	
6-Hybrid-γ	Automatically identifies the display area for the monochrome and color images on the same screen, and displays each set status.
7-sRGB	Suitable for color matching with sRGB compatible peripherals.
8-Text	Suitable for displaying texts for word processing or spreadsheets.

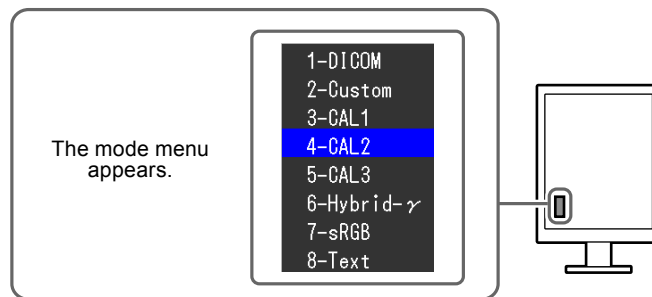

Procedure

1. Press MODE.

The mode menu appears at the bottom left of the screen.

2. The mode among the list is highlighted in turn each time MODE is pressed.

You can switch the mode with ▲ or ▼ while the mode menu is displayed.

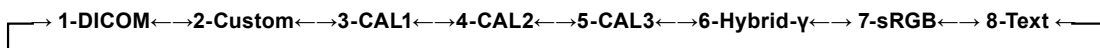

Note

- The Adjustment menu and the Mode menu cannot be displayed at the same time.

● To perform advanced adjustments

“Color” of the Adjustment menu allows you to configure and save a separate set of color settings for each mode.

Attention

- As it takes about 30 minutes for the performance of electrical parts to stabilize, adjust the monitor 30 minutes or more after the monitor power has been turned on.
- The same image may be seen in different colors on multiple monitors due to their monitor-specific characteristics. Make fine color adjustment visually when matching colors on multiple monitors.













Note

- The values shown in “%” or “K” are available only as reference.

● Adjustable settings in each mode

The adjustable settings depend on the mode. (You cannot select any non-adjustable or non-settable function.)

√: Adjustable - : Not adjustable

Icon	Function	CAL Switch mode					
		1-DICOM*	2-Custom*	3-CAL1* 4-CAL2* 5-CAL3*	6-Hybrid-γ	7-sRGB	8-Text
	Brightness	√	√	√	-	√	√
	Contrast	-	√	-	-	-	√
	Temperature	-	√	-	-	√	√
	Gamma	-	√	-	-	-	√
	Hue	-	√	-	-	-	√
	Saturation	-	√	-	-	-	√
	Gain	-	√	-	-	-	-
	Gray Area	-	-	-	√	-	-
	Color Area	-	-	-	-	-	-
	Base Area	-	-	-	√	-	-
	Hybrid Assignment	-	-	-	√	-	-
	Highlight Area	-	-	-	√	-	-
	Color Reset	√	√	√	√	√	√

* If you adjust the calibration in this mode using the calibration kit exclusive for to this monitor (see RadiCS LE / "Accessories" (page 42)), only "Brightness" and "Color Reset" are adjustable.

● To adjust brightness

The screen brightness is adjusted by changing the brightness of the backlight (light source from the LCD back panel).

Setting Range

0 to 100%

Procedure

1. Choose "Color" from the Adjustment menu, and press ENTER.
2. Choose "Brightness" from "Color", and press ENTER.
3. Use ▲ or ▼ for adjustment.
4. Press ENTER to exit.

Note

- When your feel the image is bright even if the brightness is set to 0%, adjust the contrast.

● To adjust contrast

The luminance of the screen is adjusted by varying the video signal level.

Setting Range

0 to 100%

Procedure

1. Choose “Color” from the Adjustment menu, and press ENTER.
2. Choose “Contrast” from “Color”, and press ENTER.
“Contrast” appears.
3. Use ▲ or ▼ for adjustment.
4. Press ENTER to exit.

Note

- In the contrast of 100%, every color gradation is displayed.
 - When adjusting the monitor, it is recommended to perform the brightness adjustment which may not lose the gradation characteristics, prior to the contrast adjustment.
 - Perform the contrast adjustment in the following cases.
 - When you feel the image is too bright even if the brightness is set to 0% (Set the contrast to lower than 100%.)
-

● To adjust color temperature

The color temperature can be adjusted.

The color temperature is normally used to express the hue of “White” and/or “Black” by a numerical value.

The value is expressed in degrees “K” (Kelvin).

The screen becomes reddish at a low color temperature, and bluish at a high color temperature, like the flame temperature. The gain preset values are set for each color temperature setting value.

Setting Range

Native, 6000K-15000K (specified every 100K), User, Standard

Procedure

1. Choose “Color” from the Adjustment menu, and press ENTER.
2. Choose “Temperature” from “Color”, and press ENTER.
3. Use ▲ or ▼ for adjustment.
4. Press ENTER to exit.

Note

- “Gain” allows you to perform more advanced adjustment (see [“To adjust gain” \(page 16\)](#)).
 - If you set “Native”, the image is displayed in the preset color of the monitor (Gain: 100% for each RGB).
 - When gain is changed, the color temperature is changed to “User”.
-

● To adjust gamma

Gamma can be adjusted. The brightness of the monitor varies depending on the input signal, however, the variation rate is not proportional to the input signal. To keep the balance between the input signal and the brightness of the monitor is called as “Gamma correction”.

Setting Range

1.6 to 2.7

Procedure

1. Choose “Color” from the Adjustment menu, and press ENTER.
2. Choose “Gamma” from “Color”, and press ENTER.
3. Use ▲ or ▼ for adjustment.
4. Press ENTER to exit.

● To adjust hue

This function allows you to adjust the hue.

Setting Range

-100 to 100

Procedure

1. Choose “Color” from the Adjustment menu, and press ENTER.
2. Choose “Advanced Settings” from “Color”, and press ENTER.
3. Choose “Hue”, and press ENTER.
4. Use ▲ or ▼ for adjustment.
5. Press ENTER to exit.

Attention

- Using this function may make some color gradations unavailable for display.
-

● To adjust saturation

This function allows you to adjust color saturation.

Setting Range

-100 to 100

Procedure

1. Choose “Color” from the Adjustment menu, and press ENTER.
2. Choose “Advanced Settings” from “Color”, and press ENTER.
3. Choose “Saturation”, and press ENTER.
4. Use ▲ or ▼ for adjustment.
5. Press ENTER to exit.

Attention

- Using this function may make some color gradations unavailable for display.
-

Note

- The minimum value (-100) changes the screen to monochrome.
-

● To adjust gain

The brightness of each color component red, green, and blue is called Gain. You can change the hue of “white” by adjusting gain.

Setting Range

0 to 100%

Procedure

1. Choose “Color” from the Adjustment menu, and press ENTER.
2. Choose “Advanced Settings” from “Color”, and press ENTER.
3. Choose “Gain”, and press ENTER.
4. Choose the color for adjustment from “Red”, “Green”, and “Blue”, and press ENTER.
5. Use ▲ or ▼ for adjustment.
6. Press ENTER to exit.

Attention

- Using this function may make some color gradations unavailable for display.

Note

- The value of gain changes with that of color temperature.
 - When gain is changed, the color temperature is changed to “User”.
-

● To set the mode in the monochrome display area

The mode suitable for the monochrome image display area can be set (see [“To select the display mode \(CAL Switch mode\)”](#) (page 12)).

Setting Range

DICOM, CAL1, CAL2, CAL3

Procedure

1. Choose “Color” from the Adjustment menu, and press ENTER.
2. Choose “Gray Area” from “Color”, and press ENTER.
3. Use ▲ or ▼ for adjustment.
4. Press ENTER to exit.

Attention

- After the configuration in the display area, you cannot select any mode for which Mode Preset is “Off” (see [“3-2. Enabling/Disabling Mode Selection”](#) (page 19)).

Note

- The color image display area is “Custom” mode. “Color Area” cannot be set.
 - The Brightness is the same as the value for the mode selected. To change the brightness, use the mode selected for adjustment.
-

● To set the mode in the base display area

The mode suitable for the base display area can be set.

Setting Range

Base-L, Base-H, Custom

Procedure

1. Choose “Color” from the Adjustment menu, and press ENTER.
2. Choose “Base Area” from “Color”, and press ENTER.
3. Select “Base-L”, “Base-H”, or “Custom” with ▲ or ▼.

Mode	Purpose
Base-L	Specifies the target brightness at 100 cd/m ² (with color temperature of 7500K).
Base-H	Specifies the target brightness to 170 cd/m ² (with color temperature of 7500K).
Custom	Specifies to the preset value of the Custom mode (“To select the display mode (CAL Switch mode)” (page 12)).

4. Press ENTER to exit.

Attention

- After the configuration in the display area, you cannot select any mode for which Mode Preset is “Off” (see “3-2. Enabling/Disabling Mode Selection” (page 19)).

Note

- If the brightness value in the base display area is higher than the target brightness, the target brightness is applied for Base-L and Base-H. Also, other preset values are the same as “Custom”.

● To set the detection type in the image display area

You can set the detection type in the display area.

Procedure

1. Choose “Color” from the Adjustment menu, and press ENTER.
2. Choose “Hybrid Assignment” from “Color”, and press ENTER.
3. Select “Full Scan”, “Partial Scan”, or “Custom” with ▲ or ▼.

Detection Type	Purpose
Full Scan	Identifies the display area automatically.
Partial Scan	Identifies the selection area using software (Hybrid Gamma Manager) automatically.
Custom	Allows you to set the display area manually using software (Hybrid Gamma Manager).

4. Press ENTER to exit.

Note

- For Hybrid Gamma Manager, contact your local EIZO representative.

● To set the highlight area in the image display area

You can set On/Off for the highlight area in the image display area.

Procedure

1. Choose “Color” from the Adjustment menu, and press ENTER.
2. Choose “Highlight Area” from “Color”, and press ENTER.
3. Select “On” or “Off” with ▲ or ▼.
4. Press ENTER to exit.

Note

- When “On” is specified, the monochrome display area is displayed in green, and the color display area is displayed in red.
- You can set On/Off for the highlight area with ▼.

2-4. Selecting Screen Size

The image with the resolution other than the recommended resolution is displayed in full screen automatically. You can change the screen size by using the “Screen Size” function from “Screen”.

Settings	Function
Full	Displays an image in full screen. Images are distorted in some cases because the vertical rate is not equal to the horizontal rate.
Enlarged	Displays an image in full screen. In some cases, a blank horizontal or vertical border appears to equalize the vertical rate and the horizontal rate.
Normal	Displays images with the specified resolution.

Example: Image size 1024 × 768

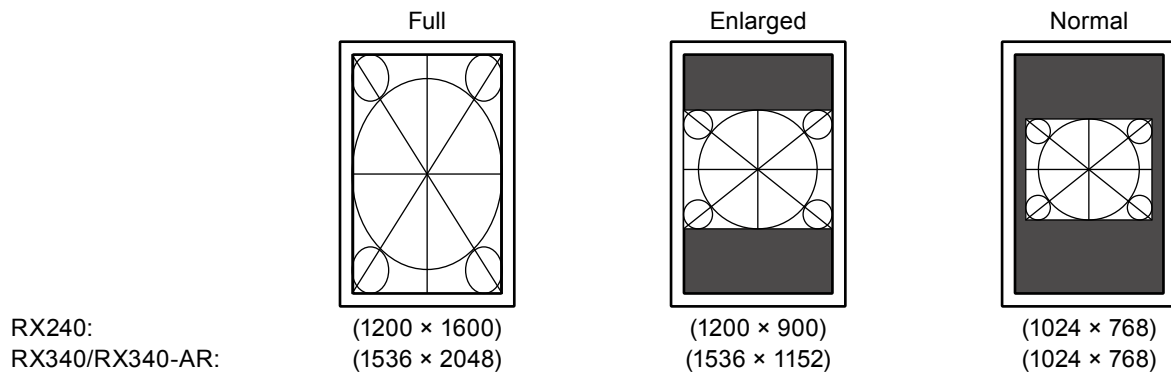

Procedure

1. Choose “Screen” from the Adjustment menu, and press ENTER.
2. Choose “Screen Size” from “Screen”, and press ENTER.
3. Select “Full”, “Enlarged”, or “Normal” with ▲ or ▼.
4. Press ENTER to exit.

Attention

- Selecting “Normal” may make some color gradations unavailable for display.

Chapter 3 Setting Monitor





3-1. Setting Orientation



This function changes the display orientation of the image based on the operating environment.



Attention

- Refer to the User's Manual of the graphics board.
- Setting is available even when the PC is not started up.

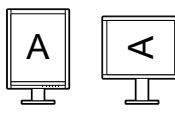
Procedure

1. Press  to turn off the monitor.
2. Holding MODE down, press  for at least two seconds to turn on the monitor.
The "Optional Settings" menu appears.
3. Choose "Orientation" from "Optional Settings", and press ENTER.
4. Choose "Landscape", "Portrait (SW)", or "Portrait (HW)" with  or , and press ENTER.

Monitor Orientation	Display Example
Landscape Select this option when using the Landscape orientation.	
Portrait (SW) Select this option when using the Portrait orientation. Graphics board utility software is used to rotate the display image 90 degrees.	
Portrait (HW) Select this option when using the Portrait orientation. The monitor function is used to rotate the display image 90 degrees.	





5. Select "Finish" with  or .
6. Press ENTER.
The "Optional Settings" menu is closed.

3-2. Enabling/Disabling Mode Selection

Allows you to select the specified modes only.

Use this function when all the display modes are not available or when keeping the display mode unchanged.

Procedure

1. Choose "Tools" from the Adjustment menu, and press ENTER.
2. Choose "Mode Preset" from "Tools", and press ENTER.
3. Use  or  to select the mode to change, and press ENTER.
4. Select "On" or "Off" with  or .
5. Press ENTER to exit.

Attention

- You cannot set all the modes disable. Set at least one mode to "On".

3-3. Setting Language

This function allows you to select a language for the Adjustment menu and messages.

Selectable languages

English/German/French/Spanish/Italian/Swedish/Japanese/Simplified Chinese/Traditional Chinese

Procedure

1. Choose “Menu Settings” from the Adjustment menu, and press ENTER.
2. Choose “Language” from “Menu Settings”, and press ENTER.
3. Select a language with ▲ or ▼.
4. Press ENTER to exit.

3-4. Setting Adjustment Menu Display

● Changing Adjustment Menu Display Position

You can change the display position of the Adjustment menu.

Procedure

1. Choose “Menu Settings” from the Adjustment menu, and press ENTER.
2. Choose “Menu Position” from “Menu Settings”, and press ENTER.
3. Choose the position with ▲ or ▼.
4. Press ENTER to exit.

3-5. Setting the EIZO Logo Display

This function allows you to display, or not, the EIZO logo.

Procedure

1. Press ⏻ to turn off the monitor.
2. Holding MODE down, press ⏻ for at least two seconds to turn on the monitor.
The “Optional Settings” menu appears.
3. Choose “Logo” from “Optional Settings”, and press ENTER.
4. Select “On” or “Off” with ▲ or ▼, and press ENTER.
5. Select “Finish” with ▲ or ▼.
6. Press ENTER.
The “Optional Settings” menu is closed.

3-6. Locking Buttons

This function allows you to lock the adjusted/set status to prevent changing them.

Procedure

1. Press **⏻** to turn off the monitor.
2. Holding **MODE** down, press **⏻** for at least two seconds to turn on the monitor.
The “Optional Settings” menu appears.
3. Choose “Key Lock” from “Optional Settings”, and press **ENTER**.
4. Choose “Off”, “Menu”, or “All” with **▲** or **▼**, and press **ENTER**.

Settings	Buttons that can be locked
Off (Default setting)	None (All buttons are enabled)
Menu	ENTER button
All	All buttons excluding ⏻

5. Select “Finish” with **▲** or **▼**.
6. Press **ENTER**.
The “Optional Settings” menu is closed.

3-7. Enabling/Disabling DDC Communication

This function allows you to enable/disable the DDC communication. Normally, turn it on during use. (This is different from the DDC/CI communication.)

Procedure

1. Press **⏻** to turn off the monitor.
2. Holding **MODE** down, press **⏻** for at least two seconds to turn on the monitor.
The “Optional Settings” menu appears.
3. Choose “DDC” from “Optional Settings”, and press **ENTER**.
4. Select “On” or “Off” with **▲** or **▼**, and press **ENTER**.
5. Select “Finish” with **▲** or **▼**.
6. Press **ENTER**.
The “Optional Settings” menu is closed.

3-8. Enabling/Disabling DC5V Output

This function allows you to enable/disable the DC5V output. Normally, turn it off during use.

Procedure

1. Press **⏻** to turn off the monitor.
2. Holding **MODE** down, press **⏻** for at least two seconds to turn on the monitor.
The “Optional Settings” menu appears.
3. Choose “DC5V Output” from “Optional Settings”, and press **ENTER**.
4. Select “On” or “Off” with **▲** or **▼**, and press **ENTER**.
5. Select “Finish” with **▲** or **▼**.
6. Press **ENTER**.
The “Optional Settings” menu is closed.

3-9. Return To Default Setting

There are two different Resets: Color Reset for only resetting the color adjustments to the default settings and All Reset for resetting all settings to the defaults.

Attention

- After resetting, you cannot undo the operation.

Note

- Regarding the default setting, see [“Main Default Settings”](#) (page 40).
-

● To reset the color adjustments

This function only resets the color adjustment value for the currently selected mode to the default settings.

Procedure

1. Choose “Color” from the Adjustment menu, and press ENTER.
2. Choose “Color Reset” from “Color”, and press ENTER.
3. Select “Execute” with ▲ or ▼.
4. Press ENTER.

The color adjustments revert to the default settings.

● To reset all settings

This function resets all adjustments to the default settings (except the “Input” and “Optional Settings” menus).

Procedure

1. Choose “Tools” from the Adjustment menu, and press ENTER.
2. Choose “All Reset” from “Tools”, and press ENTER.
3. Select “Execute” with ▲ or ▼.
4. Press ENTER.

All settings excluding the “Input” and “Optional Settings” menus are reset to the default settings.

Chapter 4 Controlling Monitor Quality

This product has the built-in Integrated Front Sensor, which allows the user to perform periodic calibration and Grayscale Check for the monitor independently.

Attention

- When a panel protector (RP-902/RP-903) is installed, the Integrated Front Sensor cannot be used. Do not execute “SelfCalibration” or “Grayscale Check” of “RadiCS SelfQC”. Be sure to set “Meas. Frequency” to “Off”.
- When a panel protector (RP-912/RP-913) is installed, the Integrated Front Sensor can be used. After installation, be sure to execute correlation using RadiCS/RadiCS LE.

Note

- To perform advanced quality control that conforms to medical standards, use the optional monitor quality control software kit “RadiCS UX1”.
 - Perform correlation using RadiCS/RadiCS LE to adjust the measurement result of the Integrated Front Sensor to the measurement result of the UX1 sensor for reference. Periodical correlation enables the measurement accuracy of the Integrated Front Sensor equivalent to that of the UX1 sensor. For details, refer to RadiCS/RadiCS LE User’s Manual.
 - “RadiCS” allows you to set the adjustment target for the calibration and judgment value for Grayscale Check, and also the schedule for the calibration and Grayscale Check.
 - The supplied “RadiCS LE” software also allows you to set the adjustment target and schedule for the calibration. For details, refer to “RadiCS LE User’s Manual” (on the CD-ROM).
-

4-1. Executing Calibration

This function allows you to execute SelfCalibration and view the latest result. In addition, when the schedule is set using RadiCS/RadiCS LE, the next calibration schedule appears.

● Executing SelfCalibration

Attention

- Do not execute this function when a panel protector (RP-902/RP-903) is installed.
 - After SelfCalibration is executed, execute Grayscale Check under the actual temperature of the monitor usage environment.
-

Procedure

1. Choose “RadiCS SelfQC” from the Adjustment menu, and press ENTER.
2. Choose “SelfCalibration” from the “RadiCS SelfQC” menu, and press ENTER.
3. Select “Execute” with ▲ or ▼.
4. Press ENTER to exit.
SelfCalibration is executed.

● Viewing SelfCalibration result

Attention

- The result can be viewed when “QC History” is “On” (see “4-4. Setting On/Off for Warning and QC History” (page 25)).
-

Procedure

1. Choose “RadiCS SelfQC” from the Adjustment menu, and press ENTER.
 2. Choose “SelfCalibration” from the “RadiCS SelfQC” menu, and press ENTER.
 3. Select “Result” with ▲ or ▼.
 4. Select “DICOM”, “Custom”, “CAL1”, “CAL2” or “CAL3” with ▲ or ▼.
 5. Press ENTER to exit.
The SelfCalibration result (Max. Error Rate, Last Time, and Error Code) appears.
-

4-2. Checking Grayscale

This function allows you to execute Grayscale Check and view the latest result. In addition, when the schedule is set using RadiCS, the next grayscale check schedule appears.

● Executing Grayscale Check

Attention

- Do not execute this function when a panel protector (RP-902/RP-903) is installed.
 - Execute Grayscale Check under the actual temperature of the monitor usage environment.
-

Procedure

1. Choose “RadiCS SelfQC” from the Adjustment menu, and press ENTER.
2. Choose “Grayscale Check” from the “RadiCS SelfQC” menu, and press ENTER.
3. Select “Execute” with ▲ or ▼.
4. Press ENTER to exit.

Grayscale Check is executed.

● Viewing Grayscale Check result

Attention

- The result can be viewed when “QC History” is “On”.
-

Procedure

1. Choose “RadiCS SelfQC” from the Adjustment menu, and press ENTER.
2. Choose “Grayscale Check” from the “RadiCS SelfQC” menu, and press ENTER.
3. Select “Result” with ▲ or ▼.
4. Select “DICOM”, “Custom”, “CAL1”, “CAL2” or “CAL3” with ▲ or ▼.
5. Press ENTER to exit.

Up to the five latest Grayscale Check results (Passed/Failed/Canceled/ERR) appear.

4-3. Acquiring Life Prediction Data

This function allows you to acquire data necessary to predict the monitor life.

Attention

- When a panel protector (RP-902/RP-903) is installed, be sure to set “Meas. Frequency” to “Off”.
-

Note

- Data are collected every 100 hours.
 - When you select “Power Save”, data are collected when the mode switches to Power Save or the secondary power off after the above timing is reached.
 - When you select “Routine”, data are saved after the following times have elapsed.
 - 500, 1000, 2000, 4000, 7000, 10000, 15000, 20000, 25000, 30000 hours
-

Procedure

1. Choose “RadiCS SelfQC” from the Adjustment menu, and press ENTER.
2. Choose “LEA” from the “RadiCS SelfQC” menu, and press ENTER.
3. Select “Meas. Frequency” with ▲ or ▼.
4. Select “Power Save”, “Routine”, or “Off” with ▲ or ▼.
5. Press ENTER to exit.

4-4. Setting On/Off for Warning and QC History

This function allows you to set On/Off for Warning and QC History when the Grayscale Check result is Failed.

Procedure

1. Choose “RadiCS SelfQC” from the Adjustment menu, and press ENTER.
2. Choose “Settings” from the “RadiCS SelfQC” menu, and press ENTER.
3. Select “Warning” or “QC History” with ▲ or ▼.
4. Select “On” or “Off” with ▲ or ▼.
5. Press ENTER to exit.

Chapter 5 Power Saving Functions

5-1. Setting Power Save

This function allows you to set the monitor into the power saving mode according to the PC status. When the monitor has shifted to the power saving mode, the images on the screen are not displayed.

Attention

- Turning off the main power switch or unplugging the power cord completely shuts off power supply to the monitor.
- Devices connected to the USB upstream port and USB downstream port work when the monitor is in power saving mode or when the power button of the monitor is Off. Therefore, power consumption of the monitor varies with connected devices even in the power saving mode.
- Five seconds before the monitor enters the power saving mode, it displays a preliminary message.

Procedure

1. Choose “PowerManager” from the Adjustment menu, and press ENTER.
2. Choose “Power Save” from “PowerManager”, and press ENTER.
3. Select “Off” and either “High” or “Low” with ▲ or ▼.

Settings	Function
High	Turns off the backlight. The power saving effect is the greatest.
Low	Turns down the backlight to the lowest setting. The time until the operation stabilizes after exiting the Power Save mode next time can be reduced.

4. Press ENTER to exit.

Power Saving System

At DVI signal input

This monitor complies with the “DVI DMPM” standard.

At DisplayPort signal input

This monitor complies with the “DisplayPort Standard V1.1a”.

The monitor enters the power saving mode after five seconds in connection with the PC setting.

PC	Monitor	Power Indicator
On	Operating	Green
Power saving mode	Power saving mode	Orange

5-2. Setting Power Indicator

The brightness of the power indicator (green) when the screen is displayed can be adjusted (default setting is set to light up when power is turned on, and brightness is set to 4).

Procedure

1. Choose “PowerManager” from the Adjustment menu, and press ENTER.
2. Choose “Power Indicator” from “PowerManager”, and press ENTER.
3. Select the indicator brightness “Off” or in the range from 1 to 7 with ▲ or ▼ as desired.
4. Press ENTER to exit.

5-3. Setting the power saving mode when a person leaves the monitor

The sensor on the front side of the monitor detects the movement of a person by setting a value from “Level-1” to “Level-4” of the Presence Sensor function. When a person moves away from the monitor, it shifts to the power saving mode automatically and does not display the images on the screen to reduce the power consumption. When a person comes near the monitor again, it comes back from the power saving mode and displays the images. The detection level of the Presence Sensor can be changed according to the environment of usage.

Note

- At the time of shifting to power saving mode, the message that indicates shifting is displayed.

Attention

- This function cannot be used during “RadiCS SelfQC” execution.
- It also cannot be used during the landscape position display.

Procedure

1. Choose “PowerManager” from the Adjustment menu, and press ENTER.
2. Choose “Presence Sensor” from the “PowerManager” menu, and press ENTER.
3. Select “Off” and any of “Level-1”, “Level-2”, “Level-3”, or “Level-4” (sensor detection level) with ▲ or ▼.

Detection level	Detection area	Description
Level-1	90 cm (35.4 inch) or less	If the user leaves the detection area, the monitor shifts to the power saving mode. If there is a still object within the detection area, human presence is assumed. This setting is recommended if the monitor frequently shifts to the power saving, even though a user is in front of the screen.
Level-2	70 cm (27.6 inch) or less	
Level-3	Automatically set (to 90 cm [35.4 inch] or less)	The detection area is set automatically according to human movement. If the user leaves this area, the monitor shifts to the power saving mode. Still objects in the detection area will be ignored.
Level-4	Automatically set (to 70 cm [27.6 inch] or less)	

4. Press ENTER to exit.

Chapter 6 Troubleshooting

If a problem still remains after applying the suggested remedies, contact your local dealer.

6-1. No picture

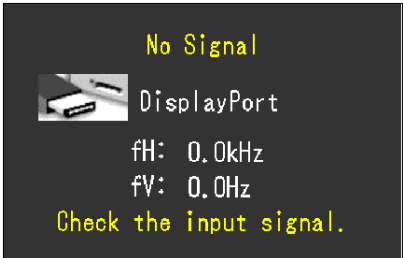
Problem	Possible cause and remedy
1. No picture <ul style="list-style-type: none"> Power indicator does not light. 	<ul style="list-style-type: none"> Check whether the power cord is connected properly. Turn the main power switch on. Press . Turn off the main power, and then turn it on again a few minutes later.
<ul style="list-style-type: none"> Power indicator is lighting green. 	<ul style="list-style-type: none"> Increase "Brightness", "Contrast", and/or "Gain" in the Adjustment menu (see "To perform advanced adjustments" (page 12)).
<ul style="list-style-type: none"> Power indicator is lighting orange. 	<ul style="list-style-type: none"> Switch the input signal (see "To switch among input signals" (page 33)). Operate the mouse or keyboard. Check whether the PC is turned on. When the Presence Sensor is set at a value from "Level-1" to "Level-4", the monitor may have shifted to the power saving mode. Come near to the monitor.
<ul style="list-style-type: none"> Power indicator flashes orange and green. 	<ul style="list-style-type: none"> There is a problem in the device that uses DisplayPort connection. Solve the problem, turn off the monitor, and then turn it on again. Refer to the user's manual of the device that uses DisplayPort connection for details.
2. The message below appears. <ul style="list-style-type: none"> This message appears when no signal is input. Example: 	<p>This message appears when the signal is not input correctly even when the monitor functions properly.</p> <ul style="list-style-type: none"> The message shown left may appear, because some PCs do not output the signal soon after power-on. Check whether the PC is turned on. Check whether the signal cable is connected properly. Switch the input signal (see "To switch among input signals" (page 33)).

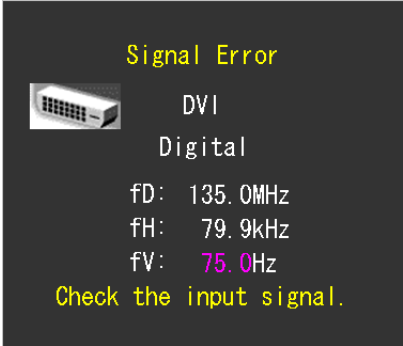
Problem	Possible cause and remedy
<ul style="list-style-type: none"> The message shows that the input signal is out of the specified frequency range. (Such signal frequency is displayed in magenta.) <p>Example:</p>  <p>fD: Dot clock fH: Horizontal scan frequency fV: Vertical scan frequency</p>	<ul style="list-style-type: none"> Check whether the PC is configured to meet the resolution and vertical scan frequency requirements of the monitor (see “Compatible Resolutions” in the Setup Manual.). Reboot the PC. Select an appropriate display mode using the graphics board’s utility. Refer to the manual of the graphics board for details.

6-2. Imaging problems

Problem	Possible cause and remedy
<p>1. The screen is too bright or too dark.</p>	<ul style="list-style-type: none"> Use “Brightness” or “Contrast” in the Adjustment menu to adjust it. (The LCD monitor backlight has a limited life span. When the screen becomes dark or begins to flicker, contact your local dealer.)
<p>2. Characters are blurred.</p>	<ul style="list-style-type: none"> Check whether the PC is configured to meet the resolution and vertical scan frequency requirements of the monitor (see “Compatible Resolutions” in the Setup Manual.).
<p>3. Afterimages appear.</p>	<ul style="list-style-type: none"> Afterimages are particular to LCD monitors. Avoid displaying the same image for a long time. Use the screen saver or power saving function to avoid displaying the same image for extended periods of time.
<p>4. Green/red/blue/white dots or defective dots remain on the screen.</p>	<ul style="list-style-type: none"> This is due to LCD panel characteristics and is not a failure.
<p>5. Interference patterns or pressure marks remain on the screen.</p>	<ul style="list-style-type: none"> Leave the monitor with a white or black screen. The symptom may disappear.

6-3. Other problems

Problem	Possible cause and remedy
1. The adjustment menu does not appear.	<ul style="list-style-type: none"> • Check whether the operation lock function works (see “3-6. Locking Buttons” (page 21)).
2. No mode menu is displayed.	<ul style="list-style-type: none"> • Check whether the operation lock function works (see “3-6. Locking Buttons” (page 21)).
3. (When using Presence Sensor) The images remain to be displayed when you move away from the monitor. / The images do not reappear when you come near it.	<ul style="list-style-type: none"> • Check the setting environment of the monitor. Presence Sensor may not work correctly in the following environments. <ul style="list-style-type: none"> - There is something that reflects light such as a mirror or glass in front of the sensor. - The monitor is located in a place that receives direct sunlight. - There is some infrared light emitting device near the monitor. - There is some obstacle in front of the sensor. • Check whether any dirt on the sensor. Clean the sensor with a soft cloth. • Check whether you are in front of the monitor. The infrared ray is emitted vertically from the sensor to detect a person.
4. The monitor connected with the USB cable is not detected. / USB devices connected to the monitor does not work.	<ul style="list-style-type: none"> • Check whether the USB cable is connected correctly (see “7-3. Making Use of USB (Universal Serial Bus)” (page 35)). • Change the USB port to another one. If the PC or peripheral devices works correctly by changing the USB port, contact your local dealer. (Refer to the manual of the PC for details.) • Reboot the PC. • If the peripheral devices work correctly when the PC and peripheral devices are connected directly, please contact your local dealer. • Check whether the PC and OS are USB compliant. (For USB compliance of the respective devices, consult their manufacturers.) • Check the PC’s BIOS setting for USB when using Windows. (Refer to the manual of the PC for details.)
5. The sensor stays out.	<ul style="list-style-type: none"> • Turn the main power off and on again.
6. SelfCalibration/Grayscale Check failure	<ul style="list-style-type: none"> • Refer to the error code table. • If an error code that does not appear in the error code table is displayed, contact your local dealer.
7. Time is not displayed correctly in the history of SelfCalibration/Grayscale Check.	<ul style="list-style-type: none"> • Execute Monitor Detection using RadiCS/RadiCS LE. For details, refer to RadiCS/RadiCS LE User’s Manual.

● Error Code Table

Error Code	Description
0***	<ul style="list-style-type: none"> • Errors that occurred during SelfCalibration
1***	<ul style="list-style-type: none"> • Errors that occurred during Grayscale Check
*1**	<ul style="list-style-type: none"> • Errors that occurred during DICOM
*2**	<ul style="list-style-type: none"> • Errors that occurred during Custom
*3**	<ul style="list-style-type: none"> • Errors that occurred during CAL1
*4**	<ul style="list-style-type: none"> • Errors that occurred during CAL2
*5**	<ul style="list-style-type: none"> • Errors that occurred during CAL3
**10	<ul style="list-style-type: none"> • The product maximum brightness may be lower than the target brightness. • Lower the target brightness.
**11	<ul style="list-style-type: none"> • The product minimum brightness may be higher than the target brightness. • Raise the target brightness.
**34	<ul style="list-style-type: none"> • The sensor may not have worked correctly. • Turn off the main power, wait for a few minutes before turning the power back on, and then execute SelfCalibration/Grayscale Check again.
**94	<ul style="list-style-type: none"> • SelfCalibration or Grayscale Check cannot be executed. • Set "Screen Size" to "Full". Or enter the Native resolution.
**95	<ul style="list-style-type: none"> • The execution conditions for SelfCalibration or Grayscale Check may not be appropriate. • Check the execution conditions and reset them if necessary.

Chapter 7 Reference

7-1. How to Attach the Arm

An optional arm (or an optional stand) can be attached by removing the stand section. Please refer to our web site for the corresponding optional arm (or optional stand). <http://www.eizo.com>

Attention

- When attaching an arm or stand, follow the instructions of their User's Manual.
- When using another manufacturer's arm or stand, confirm the following in advance and select one conforming to the VESA standard.
 - Clearance between the screw holes: 100 mm × 100 mm
 - Strong enough to support weight of the monitor unit (except the stand) and attachments such as cables.
- When using another manufacturer's arm or stand, use the screws as described below.
 - Screws fixing the stand to the monitor.
- When using an arm or stand, attach it to meet the following tilt angles of the monitor.
 - Up 45°, down 45°
- Connect the cables after attaching an arm or stand.
- Do not move the removed stand up and down. Doing so may result in injury or device damage.
- The monitor and arm or stand are heavy. Dropping them may result in injury or equipment damage.

Procedure

1. Lay the LCD monitor on a soft cloth spread over on a stable surface with the panel surface facing down.

2. Remove the stand.

Prepare a screwdriver. Loosen the screws (four) securing the unit and the stand with the screwdriver.

3. Attach the arm or stand to the monitor.

Secure the monitor to the arm or stand using the screws specified in the User's Manual of the arm or stand.

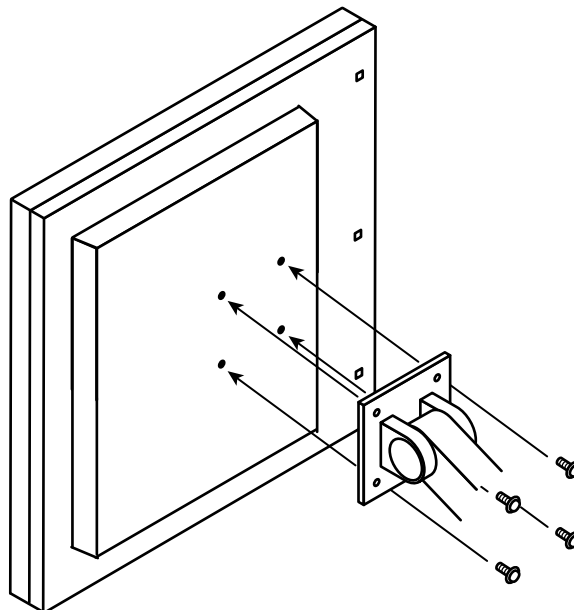

7-2. Connecting Multiple PCs

The product has multiple connections to PCs and allows you to switch to one of the connections for display.

Connection examples

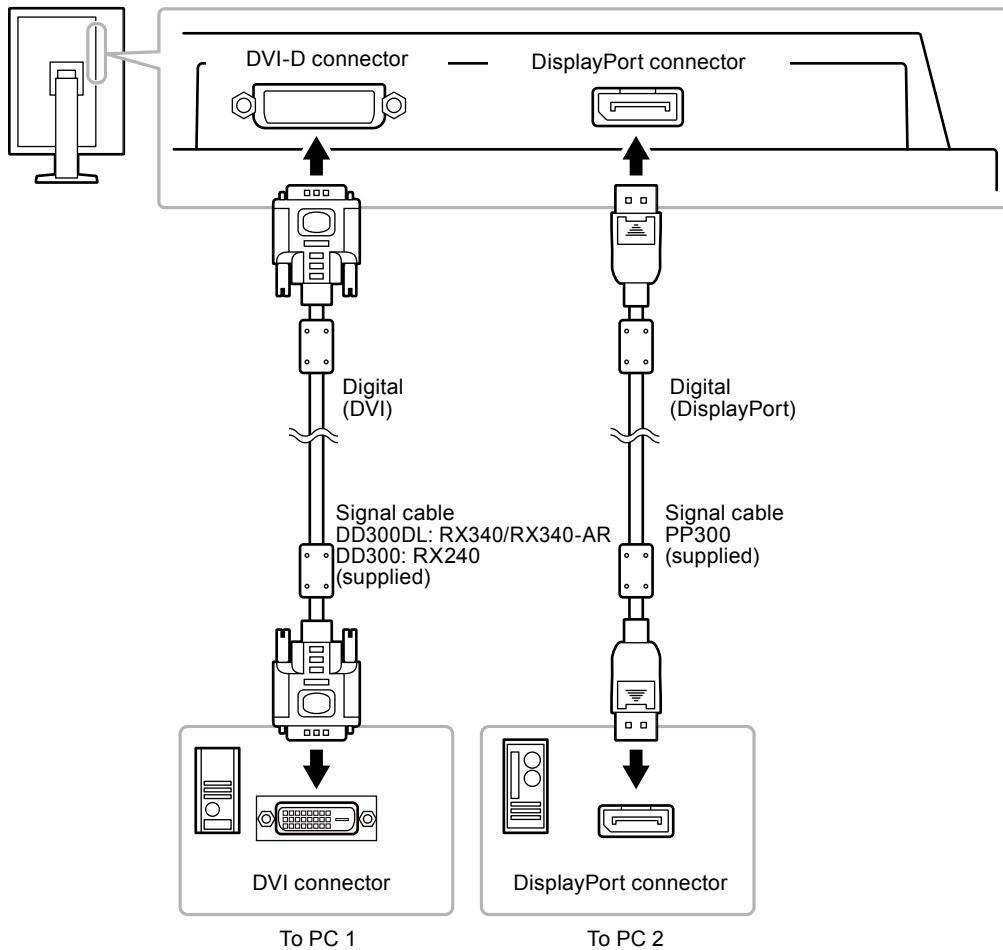

● To switch among input signals

Procedure

1. Choose “Tools” from the Adjustment menu, and press ENTER.
2. Choose “Input” from “Tools”, and press ENTER.
3. Select “DVI” or “DisplayPort” with ▲ or ▼.
4. Press ENTER to exit.

When the signal is switched, the active input port name appears at the top right corner of the screen.

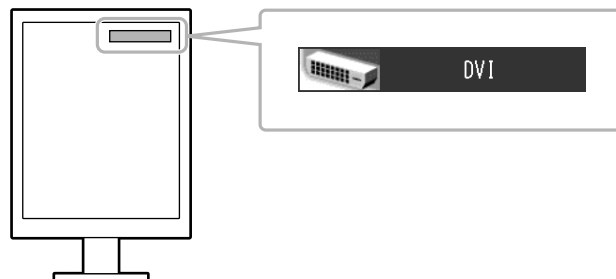

● To set input signal selection

Settings	Function
Auto	The monitor recognizes the connector through which PC signals are input. When a PC is turned off or enters the power saving mode, the monitor automatically displays another signal.
Manual	The monitor detects only the PC's signals currently displaying automatically. Select an active input signal with "Input".

Procedure

1. Choose "Tools" from the Adjustment menu, and press ENTER.
2. Choose "Input Selection" from "Tools", and press ENTER.
3. Select "Auto" or "Manual" with ▲ or ▼.
4. Press ENTER to exit.

Note

- When "Auto" is selected for "Input Selection", the monitor's power saving function works only when all PCs are in the power saving mode.
-

7-3. Making Use of USB (Universal Serial Bus)

This monitor has a hub compatible with USB. Connected to a PC compatible with USB or another USB hub, this monitor functions as a USB hub allowing connection to peripheral USB devices.

● Required system environment

1. A PC equipped with a USB port or another USB hub connected to a USB compatible PC
2. Windows 2000/XP/Vista/7/8 or Mac OS 9.2.2 and Mac OS X 10.2 or later
3. USB cable

Attention

- This monitor may not work depending on PC, OS or peripheral devices to be used. For USB compatibility of peripheral devices, contact their manufactures.
- Devices connected to the USB upstream port and USB downstream port work when the monitor is in power saving mode or when the power button of the monitor is Off. Therefore, power consumption of the monitor varies with connected devices even in the power saving mode.
- When the main power switch is Off, device connected to the USB port will not operate.

● Connection procedure (Setup of USB function)

1. Connect the monitor first to a PC using the signal cable, and run the PC.
2. Connect the supplied USB cable between the USB downstream port of a USB compatible PC (or another USB hub) and the monitor's USB upstream port.

The USB hub function is set up automatically upon connection of the USB cable.

3. Connect the peripheral USB device to the USB downstream port of the monitor.

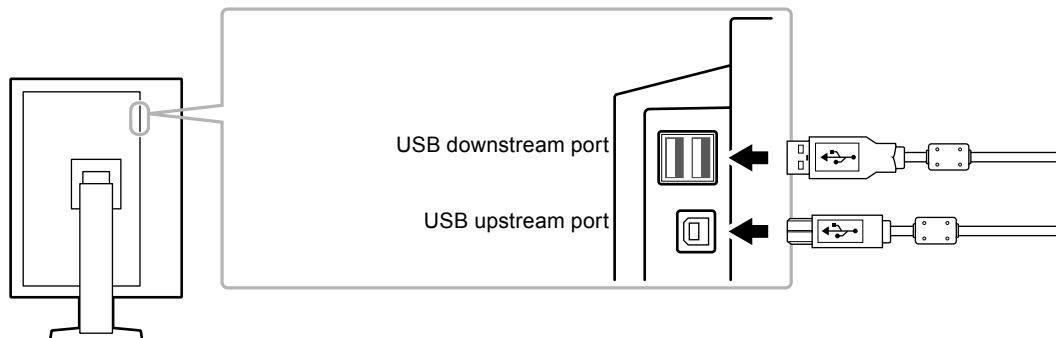

7-4. Displaying Monitor Information

● Displaying signal information

This function displays the information about the current input signals displayed.

Procedure

1. Choose “Tools” from the Adjustment menu, and press ENTER.
2. Choose “Signal Info” from “Tools”, and press ENTER.

The “Signal Info” appears.

(Example)

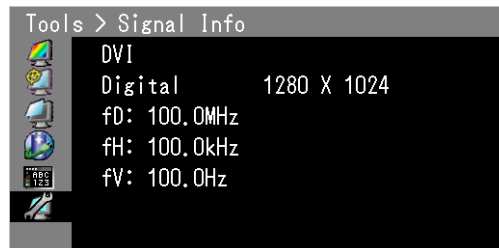

● Displaying Monitor Information

This function displays the information about the monitor.

Procedure

1. Choose “Tools” from the Adjustment menu, and press ENTER.
2. Choose “Monitor Info” from “Tools”, and press ENTER.

The “Monitor Info” appears.

This function displays the model name, serial number, firmware version, and usage time.

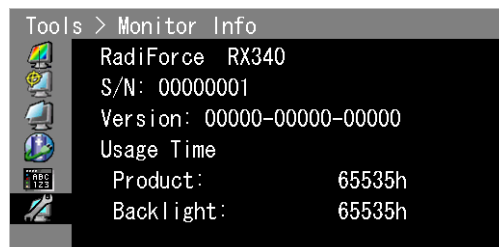

Attention

- The usage time is not always “0” when you purchase the monitor due to factory inspection.
-

7-5. Specifications

RX240

LCD Panel	Size	21.3-inch (540 mm) TFT color LCD	
	Surface treatment	Anti-glare	
	Surface hardness	2H	
	Viewing angles	Horizontal 176°, vertical 176° (CR≥10)	
	Dot pitch	0.270 mm	
	Response time	Black-white-black: Approx. 40 ms	
Horizontal scan frequency		31-100 kHz	
Vertical scan frequency		59.0-61 Hz (non-interlace)	
Resolution		2M pixels (Portrait orientation: 1200 dots × 1600 lines (H × V))	
Max. dot clock		164.5MHz	
Max. display color		Approx. 1073.74 million colors (for DisplayPort 10 bit input)	
Recommended Brightness		400 cd/m ²	
Display area (H × V)		324.0 mm (12.8 inch) × 432.0 mm (17.0 inch) (Portrait orientation)	
Power supply		100-120 Vac ±10%, 50/60 Hz 1.1-0.9A 200-240 Vac ±10%, 50/60 Hz 0.6-0.5A	
Power consumption	Screen display On	105 W or less	
	Power saving mode	1.6 W or less (when only the DVI signal connector is connected, no USB device is connected, "Input Selection" is set to "Manual", and "DC5V Output" is set to "Off".)	
	Power Off	1.6 W or less (when no USB device is connected, and "DC5V Output" is set to "Off")	
	Main power Off	0 W	
Input signal connectors		DVI-D connector DisplayPort connector (Standard V1.1a, applicable to HDCP)	
Digital Signal (DVI) Transmission System		TMDS (Single Link)	
Plug & Play		Digital (DVI-D): VESA DDC 2B / EDID structure 1.3 Digital (DisplayPort) : VESA DisplayPort / EDID structure 1.4	
Dimensions (width) × (height) × (depth)	Main unit	376 mm (14.8 inch) × 520 – 599 mm (20.5 – 23.6 inch) × 245.5 mm (9.7 inch)	
	Main unit (without stand)	376 mm (14.8 inch) × 505 mm (19.9 inch) × 98 mm (3.9 inch)	
Mass	Main unit	Approx. 10.2kg (22.5 lbs.)	
	Main unit (without stand)	Approx. 7.5kg (16.5 lbs.)	
Movable range	FlexStand2	Tilt:	Up 30°, down 0°
		Swivel:	172° right, 172° left
		Adjustable height:	170 mm (Tilt: 30°), 79 mm (Tilt: 0°)
		Rotation:	90° (counterclockwise for portrait display)
Environmental conditions	Temperature	Operating:	0°C to 35°C (32°F to 95°F)
		Transportation/Storage:	-20°C to 60°C (-4°F to 140°F)
	Humidity	Operating:	20% to 80% R.H. (no condensation)
		Transportation/Storage:	10% to 90% R.H. (no condensation)
	Air pressure	Operating:	700 hPa to 1060 hPa
		Transportation/Storage:	200 hPa to 1060 hPa

USB	Standard	USB Specification Revision 2.0
	Port	Upstream port × 1, Downstream port × 2
	Communication Speed	480 Mbps (high), 12 Mbps (full) 1.5 Mbps (low)
	Supply current	Downstream: Max. 500mA/1 port

RX340/RX340-AR

LCD Panel	Size	21.2-inch (540 mm) TFT color LCD	
	Surface treatment	RX340:	Anti-glare
		RX340-AR:	Anti-reflection
	Surface hardness	RX340:	2H
		RX340-AR:	H
	Viewing angles	Horizontal 170°, vertical 170° (CR≥50)	
	Dot pitch	0.21075 mm	
	Response time	Black-white-black: Approx. 22 ms	
Horizontal scan frequency		31 - 127 kHz	
Vertical scan frequency		29.0 - 61 Hz (non-interlace)	
Resolution		3M pixels (Portrait orientation: 1536 dots × 2048 lines (H × V))	
Max. dot clock		215MHz	
Max. display color		Approx. 1073.74 million colors (for DisplayPort 10 bit input)	
Recommended Brightness		400 cd/m ²	
Display area (H × V)		323.712 mm (12.7 inch) × 431.616 (16.7 inch) mm (Portrait orientation)	
Power supply		100 - 120 Vac ±10%, 50/60 Hz 1.3 - 1.0A 200 - 240 Vac ±10%, 50/60 Hz 0.6 - 0.5A	
Power consumption	Screen display On	125 W or less	
	Power saving mode	3.0 W or less (when only the DVI signal connector is connected, no USB device is connected, "Input Selection" is set to "Manual", and "DC5V Output" is set to "Off".)	
	Power Off	3.0 W or less (when no USB device is connected, and "DC5V Output" is set to "Off")	
	Main power Off	0 W	
Input signal connectors		DVI-D connector DisplayPort connector (Standard V1.1a, applicable to HDCP)	
Digital Signal (DVI) Transmission System		TMDS (Single Link / Dual Link)	
Plug & Play		Digital (DVI-D): VESA DDC 2B / EDID structure 1.3 Digital (DisplayPort) : VESA DisplayPort / EDID structure 1.4	
Dimensions (width) × (height) × (depth)	Main unit	376 mm (14.8 inch) × 520 – 599 mm (20.5 – 23.6 inch) × 245.5 mm (9.7 inch)	
	Main unit (without stand)	376 mm (14.8 inch) × 505 mm (19.9 inch) × 98 mm (3.9 inch)	
Mass	Main unit	Approx. 10.7kg (23.6 lbs.)	
	Main unit (without stand)	Approx. 8.0kg (17.6 lbs.)	
Movable range	FlexStand2	Tilt:	Up 30°, down 0°
		Swivel:	172° right, 172° left
		Adjustable height:	170 mm (Tilt: 30°), 79 mm (Tilt: 0°)
		Rotation:	90° (counterclockwise for portrait display)

Environmental conditions	Temperature	Operating: 0°C to 35°C (32°F to 95°F) Transportation/Storage: -20°C to 60°C (-4°F to 140°F)
	Humidity	Operating: 20% to 80% R.H. (no condensation) Transportation/Storage: 10% to 90% R.H. (no condensation)
	Air pressure	Operating: 700 hPa to 1060 hPa Transportation/Storage: 200 hPa to 1060 hPa
USB	Standard	USB Specification Revision 2.0
	Port	Upstream port × 1, Downstream port × 2
	Communication Speed	480 Mbps (high), 12 Mbps (full) 1.5 Mbps (low)
	Supply current	Downstream: Max. 500mA/1 port

Main Default Settings

CAL Switch Mode : The default display mode setting is DICOM.

RX240

Mode	Brightness	Temperature	Gamma value
DICOM	400 cd/m ²	7500K	DICOM
Custom	Approx. 400 cd/m ²	7500K	2.2
CAL1	300 cd/m ²	7500K	DICOM
CAL2	300 cd/m ²	7500K	2.2
CAL3	400 cd/m ²	7500K	DICOM
sRGB	Approx. 250 cd/m ²	6500K	2.2
Text	Approx. 100 cd/m ²	6500K	2.2

RX340

Mode	Brightness	Temperature	Gamma value
DICOM	400 cd/m ²	7500K	DICOM
Custom	Approx. 400 cd/m ²	7500K	2.2
CAL1	300 cd/m ²	7500K	DICOM
CAL2	300 cd/m ²	7500K	2.2
CAL3	400 cd/m ²	7500K	DICOM
sRGB	Approx. 250 cd/m ²	6500K	2.2
Text	Approx. 100 cd/m ²	6500K	2.2

RX340-AR

Mode	Brightness	Temperature	Gamma value
DICOM	400 cd/m ²	7500K	DICOM
Custom	Approx. 400 cd/m ²	7500K	2.2
CAL1	300 cd/m ²	7500K	DICOM
CAL2	300 cd/m ²	7500K	2.2
CAL3	400 cd/m ²	7500K	DICOM
sRGB	Approx. 250 cd/m ²	6500K	2.2
Text	Approx. 100 cd/m ²	6500K	2.2

Others

Input*	DVI
Presence Sensor	Off
Power Save	High
Input Selection	Auto
Logo*	Off
Screen Size	Normal
DDC*	On
DC5V Output*	Off
Orientation*	Portrait (HW)
Menu Position	Center
Language	English

* These functions cannot be initialized with the "All Reset" function (see [page 22](#)).

Outside Dimensions

RX240

Unit: mm (inch)

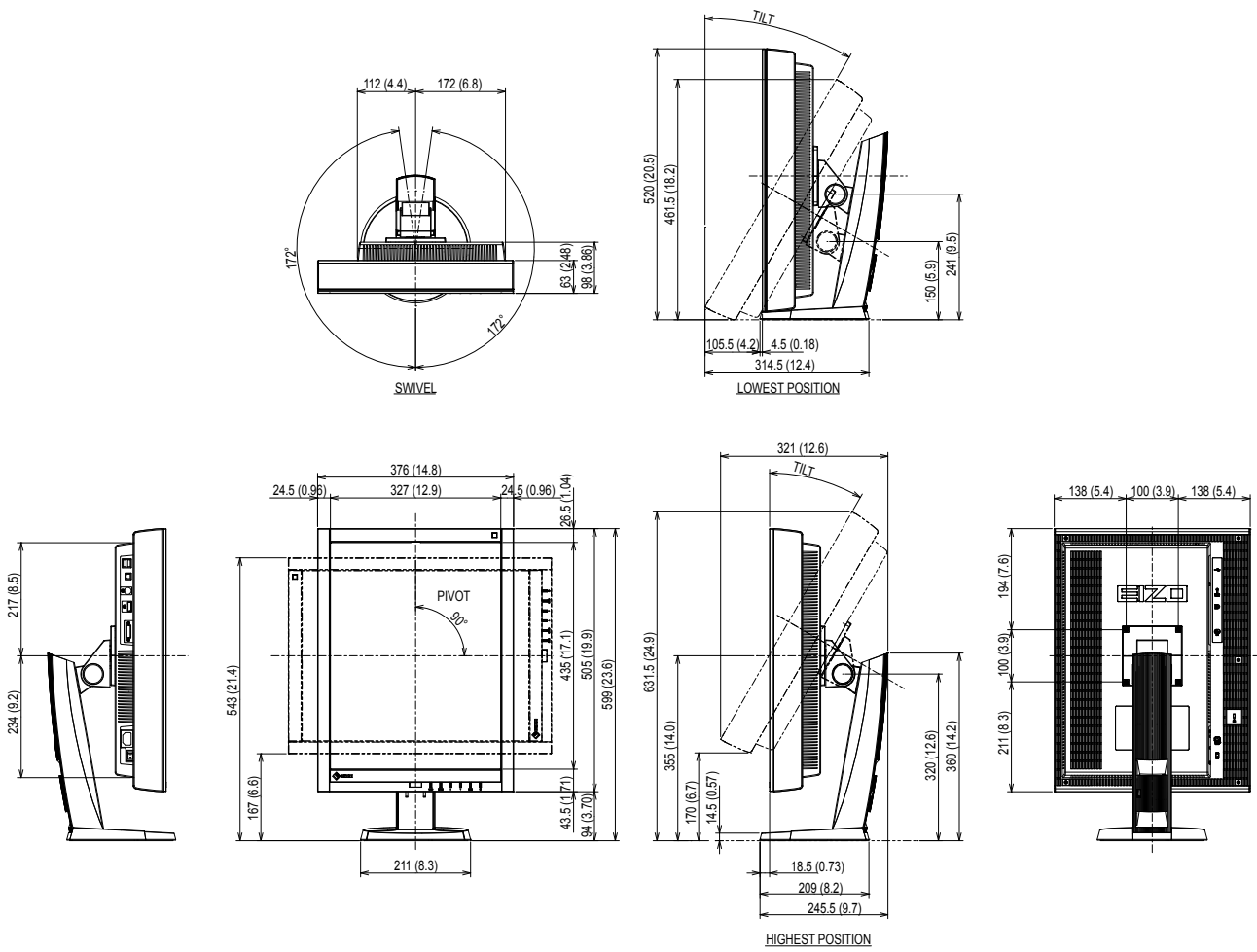

RX340/RX340-AR

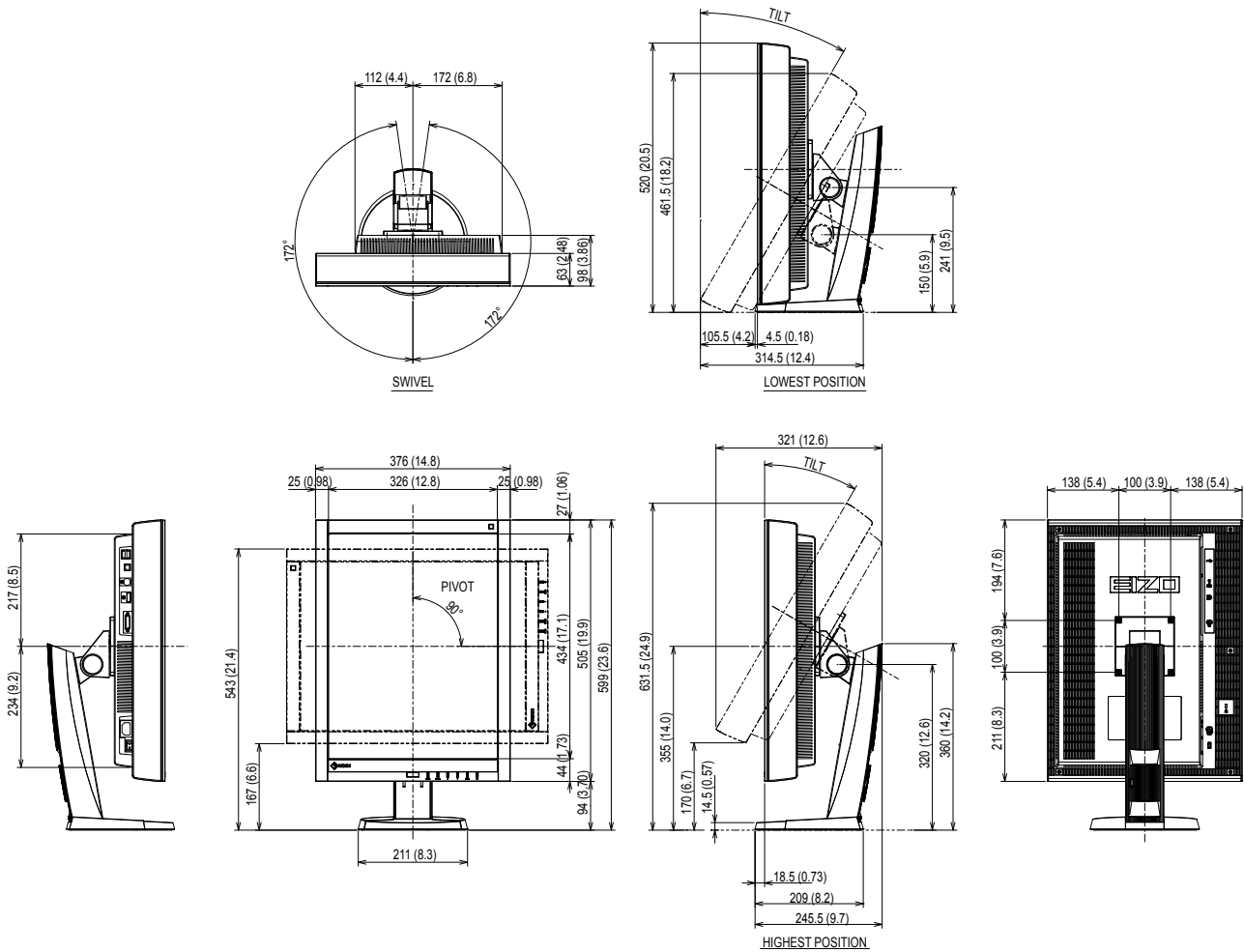

Accessories

Calibration Kit	EIZO "RadiCS UX1" Ver. 4.0.1 or later EIZO "RadiCS Version Up Kit" Ver. 4.0.1 or later
Network QC Management Software	EIZO "RadiNET Pro" Ver. 4.0.1 or later
Cleaning Kit	EIZO "ScreenCleaner"

For the latest information about the accessories and information about the latest compatible graphics board, refer to our web site.

<http://www.eizoglobal.com>

7-6. Glossary

DDC (Display Data Channel)

VESA provides the standardization for the interactive communication of the setting information, etc. between a PC and the monitor.

DICOM (Digital Imaging and Communication in Medicine)

The DICOM standard was developed by the American College of Radiology and the National Electrical Manufacturer's Association of the USA.

The DICOM compatible device connection enables to transfer the medical image and information. The DICOM, Part 14 document defines the digital, grayscale medical image display.

DisplayPort

DisplayPort is a next-generation digital AV interface that allows connection of the PC, audio, imaging devices, etc. to the monitor. One cable can transfer sound with images.

DVI (Digital Visual Interface)

DVI is a digital interface standard. DVI allows direct transmission of the PC's digital data without loss. This adopts the TMDS transmission system and DVI connectors. There are two types of DVI connectors. One is a DVI-D connector for digital signal input only. The other is a DVI-I connector for both digital and analog signal inputs.

DVI DMPM (DVI Digital Monitor Power Management)

DVI DMPM is a digital interface power saving function. The "Monitor ON (operating mode)" and "Active Off (power saving mode)" are indispensable for DVI DMPM as the monitor's power mode.

Gain

This is used to adjust each color parameter for red, green and blue. An LCD monitor displays the color by the light passing through the panel color filter. Red, green and blue are the three primary colors. All the colors on the screen are displayed by combining these three colors. The color tone can be changed by adjusting the light intensity (volume) passing through each color's filter.

Gamma

Generally, the monitor brightness varies nonlinearly with the input signal level, which is called "Gamma Characteristic". A small gamma value produces a low-contrast image, while a large gamma value produces a high-contrast image.

HDCP (High-bandwidth Digital Content Protection)

Digital signal coding system developed to copy-protect the digital contents, such as video, music, etc. This helps to transmit the digital contents safely by coding the digital contents sent via the DVI or HDMI connector on the output side and decoding them on the input side.

Any digital contents cannot be reproduced if both of the equipments on the output and input sides are not applicable to HDCP system.

Resolution

The LCD panel consists of numerous pixels of specified size, which are illuminated to form images. This monitor consists of horizontal 1200 pixels and 1600 vertical pixels (RX240), or horizontal 1536 pixels and 2048 vertical pixels (RX340/RX340-AR). At a resolution of 1200×1600 (RX240: Portrait orientation) or 1536×2048 (RX340/RX340-AR: Portrait orientation), all pixels are illuminated as a full screen (1:1).

sRGB (Standard RGB)

International standard for color reproduction and color space among peripheral devices (such as monitors, printers, digital cameras, scanners). As a form of simple color matching for the Internet, colors can be displayed using tones close to those of the transmission and reception devices.

Temperature

Color temperature is a method to measure the white color tone, generally indicated in degrees Kelvin. The screen becomes reddish at a low temperature, and bluish at a high temperature, like the flame temperature.

5000 K: Slightly reddish white

6500 K: White referred to as daylight-balanced color

9300 K: Slightly bluish white

TMDS (Transition Minimized Differential Signaling)

A signal transmission system for digital interface.

Appendix

Trademark

The DisplayPort icon and VESA are trademarks and registered trademarks of the Video Electronics Standards Association in the United States and other countries.

Windows, Windows Vista, Windows Media, SQL Server, and Xbox 360 are registered trademarks of Microsoft Corporation in the United States and other countries.

Apple, Mac, Macintosh, iMac, eMac, Mac OS, MacBook, PowerBook, ColorSync, QuickTime, and iBook are registered trademarks of Apple Inc.

Acrobat, Adobe, Adobe AIR, and Photoshop are registered trademarks of Adobe Systems Incorporated in the United States and other countries.

PowerPC is a registered trademark of International Business Machines Corporation.

Pentium is a registered trademark of Intel Corporation in the United States and other countries.

AMD Athlon and AMD Opteron are trademarks of Advanced Micro Devices, Inc.

GRACoL and IDEAlliance are registered trademarks of International Digital Enterprise Alliance.

ColorVision, ColorVision Spyder2 are registered trademarks of DataColor Holding AG.

Spyder3 is a trademark of DataColor Holding AG.

Eye-One, ColorMunki, and X-Rite are registered trademarks or trademarks of X-Rite Incorporated.

TouchWare is a trademark of 3M Touch Systems, Inc.

NextWindow is a registered trademark of NextWindow Ltd.

RealPlayer is a registered trademark of RealNetworks, Inc.

NEC is a registered trademark of NEC Corporation. PC-9801 and PC-9821 are trademarks of NEC Corporation.

PlayStation is a registered trademark of Sony Computer Entertainment Inc.

PSP and PS3 are trademarks of Sony Computer Entertainment Inc.

ENERGY STAR is a registered trademark of the United States Environmental Protection Agency in the United States and other countries.

HDMI, the HDMI logo, and High-Definition Multimedia Interface are trademarks or registered trademarks of HDMI Licensing, LLC in the United States and other countries.

EIZO, the EIZO Logo, ColorEdge, DuraVision, FlexScan, FORIS, RadiForce, RadiCS, RadiNET, Raptor, and ScreenManager are registered trademarks of EIZO Corporation in Japan and other countries.

ColorNavigator, EIZO EasyPIX, EcoView NET, EIZO ScreenSlicer, i•Sound, Screen Administrator, and UniColor Pro are trademarks of EIZO Corporation.

All other company and product names are trademarks or registered trademarks of their respective owners.

License

The bitmap font used for this product is designed by Ricoh Industrial Solutions Inc.

Medical Standards

- It shall be assured that the final system is in compliance to IEC60601-1-1 requirement.
- Power supplied equipment can emit electromagnetic waves, that could influence, limit or result in malfunction of the monitor. Install the equipment in a controlled environment, where such effects are avoided.
- This is a monitor intended for use in a medical imaging system. It does not support the display of mammography images for diagnosis.

Classification of Equipment

- Type of protection against electric shock: Class I
- EMC class: EN60601-1-2:2015 Group 1 Class B (RX340)
- Classification of medical device (MDD 93/42/EEC): Class I
- Mode of operation: Continuous
- IP Class: IPX0

EMC Information (RX340)

The RadiForce series has a performance that appropriately displays images.

Environments of Intended Use

The RadiForce series is intended to be used in Professional healthcare facility environments such as clinics and hospitals.

The following environments are not suitable for the RadiForce series to be used:

- Home healthcare environments
- In the vicinity of high-frequency surgical equipments such as electrosurgical knives
- In the vicinity of short-wave therapy equipments
- RF shielded room of the medical equipment systems for MRI
- In shielded location Special environments
- Installed in vehicles including ambulances.
- Other special environment

WARNING

The RadiForce series requires special precautions regarding EMC and need to be installed. You need to carefully read EMC Information and the “PRECAUTIONS” section in this document, and observe the following instructions when installing and operating the product.

The RadiForce series should not be used adjacent to or stacked with other equipment. If adjacent or stacked use is necessary, the equipment or system should be observed to verify normal operation in the configuration in which it will be used.

When using a portable RF communication equipment, keep it 30 cm (12 inches) or more away from any part, including cables, of the RadiForce series. Otherwise, degradation of the performance of this equipment could result.

Anyone who connects additional equipment to the signal input part or signal output parts, configuring a medical system, is responsible that the system complies with the requirements of IEC/EN60601-1-2.

Be sure to use the cables attached to the product, or cables specified by EIZO.

Use of cables other than those specified or provided by EIZO of this equipment could result in increased electromagnetic emissions or decreased electromagnetic immunity of this equipment and improper operation.

Cables	EIZO Designated Cables	Max. Cable Length	Shielding	Ferrite Core
Signal cable (DisplayPort)	PP300 / PP200	3 m	Shielded	With Ferrite Cores
Signal cable (DVI-D)	DD300DL / DD200DL	3 m	Shielded	With Ferrite Cores
USB cable	UU300 / MD-C93	3 m	Shielded	With Ferrite Cores
Power cord (with earth)	-	3 m	Unshielded	Without Ferrite Cores

Technical Descriptions

Electromagnetic emissions		
The RadiForce series is intended for use in the electromagnetic environment specified below. The customer or the user of the RadiForce series should assure that it is used in such an environment.		
Emission test	Compliance	Electromagnetic environment - Guidance
RF emissions CISPR11 / EN55011	Group 1	The RadiForce series uses RF energy only for its internal function. Therefore, its RF emission are very low and are not likely to cause any interference in nearby electronic equipment.
RF emissions CISPR11 / EN55011	Class B	The RadiForce series is suitable for use in all establishments, including domestic establishments and those directly connected to the public low-voltage power supply network that supplies buildings used for domestic purposes.
Harmonic emissions IEC / EN61000-3-2	Class D	
Voltage fluctuations / flicker emissions IEC / EN61000-3-3	Complies	

Electromagnetic immunity			
The RadiForce series has been tested at the following compliance levels according to the testing requirements for professional healthcare facility environments defined in IEC / EN60601-1-2. Customers and users of the RadiForce series must ensure that the RadiForce series is used in the following environments:			
Immunity test	Test level for professional healthcare facility environments	Compliance level	Electromagnetic environment - Guidance
Electrostatic discharge (ESD) IEC / EN61000-4-2	±8 kV contact discharge ±15 kV air discharge	±8 kV contact discharge ±15 kV air discharge	Floors should be wood, concrete or ceramic tile. If floors are covered with synthetic material, the relative humidity should be at least 30%.
Electrical fast transients / bursts IEC / EN61000-4-4	±2 kV power lines ±1 kV input / output lines	±2 kV power lines ±1 kV input / output lines	Mains power quality should be that of a typical commercial or hospital environment.
Surges IEC / EN61000-4-5	±1 kV line to line ±2 kV line to ground	±1 kV line to line ±2 kV line to ground	Mains power quality should be that of a typical commercial or hospital environment.
Voltage dips, short interruptions and voltage variations on power supply input lines IEC / EN61000-4-11	0 % U_T (100 % dip in U_T) 0.5 cycles and 1 cycle 70 % U_T (30 % dip in U_T) 25 cycles 0 % U_T (100 % dip in U_T) 5 sec	0 % U_T (100 % dip in U_T) 0.5 cycles and 1 cycle 70 % U_T (30 % dip in U_T) 25 cycles 0 % U_T (100 % dip in U_T) 5 sec	Mains power quality should be that of a typical commercial or hospital environment. If the user of the RadiForce series requires continued operation during power mains interruptions, it is recommended that the RadiForce series be powered from an uninterruptible power supply or a battery.
Power frequency magnetic fields IEC / EN61000-4-8	30 A/m (50 / 60 Hz)	30 A/m	Power frequency magnetic fields should be at levels characteristic of a typical location in a typical commercial or hospital environment. The product should be kept at least 15 cm away from the source of power frequency magnetic fields during use.

Electromagnetic immunity

The RadiForce series has been tested at the following compliance levels according to the testing requirements for professional healthcare facility environments defined in IEC / EN60601-1-2.

Customers and users of the RadiForce series must ensure that the RadiForce series is used in the following environments:

Immunity test	Test level for professional healthcare facility environments	Compliance level	Electromagnetic environment - Guidance
Conducted disturbances induced by RF fields IEC / EN61000-4-6	3 Vrms 150 kHz - 80 MHz	3 Vrms	Portable and mobile RF communications equipment should be used no closer to any part of the RadiForce series, including cables, than the recommended separation distance calculated from the equation applicable to the frequency of the transmitter. Recommended separation distance $d = 1.2\sqrt{P}$
Radiated RF fields IEC / EN61000-4-3	6 Vrms ISM bands between 150 kHz and 80 MHz 3 V/m 80 MHz - 2.7 GHz	6 Vrms 3 V/m	
			$d = 1.2\sqrt{P}$, 80 MHz - 800 MHz $d = 2.3\sqrt{P}$, 800 MHz - 2.7 GHz Where "P" is the maximum output power rating of the transmitter in watts (W) according to the transmitter manufacturer and "d" is the recommended separation distance in meters (m). Field strengths from fixed RF transmitters, as determined by an electromagnetic site survey ^{a)} , should be less than the compliance level in each frequency range ^{b)} . Interference may occur in the vicinity of equipment marked with the following symbol. 

Note 1 | U_T is the a.c. mains voltage prior to application of the test level.

Note 2 | At 80 MHz and 800 MHz, the higher frequency range applies.

Note 3 | Guidelines regarding conducted disturbances induced by RF fields or radiated RF fields may not apply in all situations. Electromagnetic propagation is affected by absorption and reflection from structures, objects and people.

Note 4 | The ISM bands between 150 kHz and 80 MHz are 6.765 MHz to 6.795 MHz, 13.553 MHz to 13.567 MHz, 26.957 MHz to 27.283 MHz, and 40.66 MHz to 40.70 MHz.

a) | Field strengths from fixed transmitters, such as base stations for radio (cellular/cordless) telephones and land mobile radios, amateur radio, AM and FM radio broadcast and TV broadcast cannot be predicted theoretically with accuracy. To assess the electromagnetic environment due to fixed RF transmitters, an electromagnetic site survey should be considered. If the measured field strength in the location in which the RadiForce series is used exceeds the applicable RF compliance level above, the RadiForce series should be observed to verify normal operation. If abnormal performance is observed, additional measures may be necessary, such as reorienting or relocating the RadiForce series.

b) | Over the frequency range 150 kHz to 80 MHz, field strengths should be less than 3 V/m.

Recommended separation distances between portable or mobile RF communication equipment and the RadiForce Series

The RadiForce series is intended for use in an electromagnetic environment in which radiated RF disturbances are controlled. The customer or the user of the RadiForce series can help prevent electromagnetic interference by maintaining a minimum distance between portable and mobile RF communications equipment (transmitters) and the RadiForce series.

Immunity to proximity fields from following RF wireless communication equipments has been confirmed:

Test frequency (MHz)	Bandwidth ^{a)} (MHz)	Service ^{a)}	Modulation ^{b)}	Maximum power (W)	Minimum separation distance (m)	IEC / EN60601 test level (V/m)	Compliance level (V/m)
385	380 - 390	TETRA 400	Pulse modulation ^{b)} 18 Hz	1.8	0.3	27	27
450	430 - 470	GMRS 460, FRS 460	FM ±5 kHz deviation 1 kHz sine	2	0.3	28	28
710	704 - 787	LTE Band 13, 17	Pulse modulation ^{b)} 217 Hz	0.2	0.3	9	9
745							
780							
810	800 - 960	GSM 800 / 900, TETRA 800, iDEN 820 CDMA 850, LTE Band 5	Pulse modulation ^{b)} 18 Hz	2	0.3	28	28
870							
930							
1720	1700 - 1990	GSM 1800; CDMA 1900; GSM 1900; DECT; LTE Band 1, 3, 4, 25; UMTS	Pulse modulation ^{b)} 217 Hz	2	0.3	28	28
1845							
1970							
2450	2400 - 2570	Bluetooth, WLAN, 802.11 b/g/n, RFID 2450, LTE Band 7	Pulse modulation ^{b)} 217 Hz	2	0.3	28	28
5240	5100 - 5800	WLAN 802.11 a/n	Pulse modulation ^{b)} 217 Hz	0.2	0.3	9	9
5500							
5785							
a)	For some services, only the uplink frequencies are included.						
b)	Carrier waves are modulated using a 50 % duty cycle square wave signal.						

The RadiForce series is intended for use in an electromagnetic environment in which radiated RF disturbances are controlled. For other portable and mobile RF communication equipments (transmitters), minimum distance between portable and mobile RF communications equipment (transmitters) and the RadiForce series as recommended below, according to the maximum output power of the communications equipment.

Rated maximum output power of transmitter (W)	Separation distance according to frequency of transmitter (m)		
	150 kHz to 80 MHz $d = 1.2\sqrt{P}$	80 MHz to 800 MHz $d = 1.2\sqrt{P}$	800 MHz to 2.7 GHz $d = 2.3\sqrt{P}$
0.01	0.12	0.12	0.23
0.1	0.38	0.38	0.73
1	1.2	1.2	2.3
10	3.8	3.8	7.3
100	12	12	23

For transmitters rated at a maximum output power not listed above, the recommended separation distance “d” in meters (m) can be estimated using the equation applicable to the frequency of the transmitter, where “P” is the maximum output power rating of the transmitter in watts (W) according to the transmitter manufacturer.

Note 1	At 80 MHz and 800 MHz, the separation distance for a higher frequency range applies.
Note 2	These guidelines may not apply in all situations. Electromagnetic propagation is affected by absorption and reflection from structures, objects and people.

FCC Declaration of Conformity

For U.S.A. , Canada, etc. (rated 100-120 Vac) Only

FCC Declaration of Conformity

We, the Responsible Party

EIZO Inc.

5710 Warland Drive, Cypress, CA 90630

Phone: (562) 431-5011

declare that the product

Trade name: EIZO

Model: RadiForce RX240/RX340

is in conformity with Part 15 of the FCC Rules. Operation of this product is subject to the following two conditions: (1) this device may not cause harmful interference, and (2) this device must accept any interference received, including interference that may cause undesired operation.

This equipment has been tested and found to comply with the limits for a Class B digital device, pursuant to Part 15 of the FCC Rules. These limits are designed to provide reasonable protection against harmful interference in a residential installation. This equipment generates, uses, and can radiate radio frequency energy and, if not installed and used in accordance with the instructions, may cause harmful interference to radio communications. However, there is no guarantee that interference will not occur in a particular installation. If this equipment does cause harmful interference to radio or television reception, which can be determined by turning the equipment off and on, the user is encouraged to try to correct the interference by one or more of the following measures.

- * Reorient or relocate the receiving antenna.
- * Increase the separation between the equipment and receiver.
- * Connect the equipment into an outlet on a circuit different from that to which the receiver is connected.
- * Consult the dealer or an experienced radio/TV technician for help.

Changes or modifications not expressly approved by the party responsible for compliance could void the user's authority to operate the equipment.

Note

Use the attached specified cable below or EIZO signal cable with this monitor so as to keep interference within the limits of a Class B digital device.

- AC Cord
- Shielded Signal Cable (enclosed)

Canadian Notice

This Class B digital apparatus complies with Canadian ICES-003.

Cet appareil numérique de la classe B est conforme à la norme NMB-003 du Canada.

LIMITED WARRANTY

LIMITED WARRANTY

EIZO Corporation (hereinafter referred to as “EIZO”) and distributors authorized by EIZO (hereinafter referred to as the “Distributors”) warrant, subject to and in accordance with the terms of this limited warranty (hereinafter referred to as the “Warranty”), to the original purchaser (hereinafter referred to as the “Original Purchaser”) who purchased the product specified in this document (hereinafter referred to as the “Product”) from EIZO or Distributors, that EIZO and Distributors shall, at their sole discretion, either repair or replace the Product at no charge if the Original Purchaser becomes aware within the Warranty Period (defined below) that (i) the Product malfunctions or is damaged in the course of normal use of the Product in accordance with the description in the instruction manual attached to the Product (hereinafter referred to as the “User’s Manual”), or (ii) the LCD panel and brightness of the Product cannot maintain the recommended brightness specified in the User’s Manual in the course of normal use of the Product in accordance with the description of the User’s Manual.

The period of this Warranty is five (5) years from the date of purchase of the Product (hereinafter referred to as the “Warranty Period”), provided that the brightness of the Product shall be warranted only if the Product has been used within the recommended brightness described in the User’s Manual and the Warranty Period for the brightness is limited to five (5) years from the date of purchase of the Product subject to the usage time being less than or equal to 20,000 hours (the brightness is 400 cd/m² and color temperature is 7500K) or less than or equal to 30,000 hours (the brightness is 300 cd/m² and color temperature is 7500K). EIZO and Distributors shall bear no liability or obligation with regard to the Product in relation to the Original Purchaser or any third parties other than as provided under this Warranty.

EIZO and Distributors will cease to hold or store any parts of the Product upon expiration of seven (7) years after the production of such parts is discontinued. In repairing the monitor, EIZO and Distributors will use renewal parts which comply with our QC standards.

The Warranty is valid only in the countries or territories where the Distributors are located. The Warranty does not restrict any legal rights of the Original Purchaser.

Notwithstanding any other provision of this Warranty, EIZO and Distributors shall have no obligation under this Warranty whatsoever in any of the cases as set forth below:

- (a) Any defect of the Product caused by freight damage, modification, alteration, abuse, misuse, accident, incorrect installation, disaster, faulty maintenance and/or improper repair by third party other than EIZO and Distributors;
- (b) Any incompatibility of the Product due to possible technical innovations and/or regulations;
- (c) Any deterioration of the sensor;
- (d) Any deterioration of display performance caused by the deterioration of expendable parts such as the LCD panel and/or backlight, etc. (e.g. changes in color, changes in color uniformity, defects in pixels including burnt pixels, etc.);
- (e) Any deterioration of the Product caused by the use at higher brightness than the recommended brightness described in the User’s Manual;
- (f) Any defect of the Product caused by external equipment;
- (g) Any defect of the Product on which the original serial number has been altered or removed;
- (h) Any normal deterioration of the product, particularly that of consumables, accessories, and/or attachments (e.g. buttons, rotating parts, cables, User’s Manual, etc.); and
- (i) Any deformation, discoloration, and/or warp of the exterior of the product including that of the surface of the LCD panel.

To obtain service under the Warranty, the Original Purchaser must deliver the Product, freight prepaid, in its original package or other adequate package affording an equal degree of protection, assuming the risk of damage and/or loss in transit, to the local Distributor. The Original Purchaser must present proof of purchase of the Product and the date of such purchase when requesting services under the Warranty.

The Warranty Period for any replaced and/or repaired product under this Warranty shall expire at the end of the original Warranty Period.

EIZO OR DISTRIBUTORS ARE NOT RESPONSIBLE FOR ANY DAMAGE TO, OR LOSS OF, DATA OR OTHER INFORMATION STORED IN ANY MEDIA OR ANY PART OF ANY PRODUCT RETURNED TO EIZO OR DISTRIBUTORS FOR REPAIR.

EIZO AND DISTRIBUTORS MAKE NO FURTHER WARRANTIES, EXPRESSED OR IMPLIED, WITH RESPECT TO THE PRODUCT AND ITS QUALITY, PERFORMANCE, MERCHANTABILITY OR FITNESS FOR ANY PARTICULAR USE. IN NO EVENT SHALL EIZO OR DISTRIBUTORS BE LIABLE FOR ANY INCIDENTAL, INDIRECT, SPECIAL, CONSEQUENTIAL OR OTHER DAMAGE WHATSOEVER (INCLUDING, WITHOUT LIMITATION, DAMAGES FOR LOSS OF PROFIT, BUSINESS INTERRUPTION, LOSS OF BUSINESS INFORMATION, OR ANY OTHER PECUNIARY LOSS) ARISING OUT OF THE USE OR INABILITY TO USE THE PRODUCT OR IN ANY CONNECTION WITH THE PRODUCT, WHETHER BASED ON CONTRACT, TORT, NEGLIGENCE, STRICT LIABILITY OR OTHERWISE, EVEN IF EIZO OR DISTRIBUTORS HAVE BEEN ADVISED OF THE POSSIBILITY OF SUCH DAMAGES. THIS EXCLUSION ALSO INCLUDES ANY LIABILITY WHICH MAY ARISE OUT OF THIRD PARTY CLAIMS AGAINST THE ORIGINAL PURCHASER. THE ESSENCE OF THIS PROVISION IS TO LIMIT THE POTENTIAL LIABILITY OF EIZO AND DISTRIBUTORS ARISING OUT OF THIS LIMITED WARRANTY AND/OR SALES.

BEGRENZTE GARANTIE

EIZO Corporation (im Weiteren als „**EIZO**“ bezeichnet) und die Vertragsimporteure von EIZO (im Weiteren als „**Vertrieb(e)**“ bezeichnet) garantieren dem ursprünglichen Käufer (im Weiteren als „**Erstkäufer**“ bezeichnet), der das in diesem Dokument vorgegebene Produkt (im Weiteren als „**Produkt**“ bezeichnet) von EIZO oder einem Vertrieb erworben hat, gemäß den Bedingungen dieser beschränkten Garantie (im Weiteren als „**Garantie**“ bezeichnet), dass EIZO und der Vertrieb nach eigenem Ermessen das Produkt entweder kostenlos reparieren oder austauschen, falls der Erstkäufer innerhalb der Garantiefrist (weiter unten festgelegt) entweder (i) eine Fehlfunktion bzw. Beschädigung des Produkts feststellt, die während des normalen Gebrauchs des Produkts gemäß den Anweisungen des zum Lieferumfang des Produkts gehörenden Benutzerhandbuchs (im Weiteren als „**Benutzerhandbuch**“ bezeichnet) aufgetreten ist, oder (ii) das LCD-Panel und die Helligkeit des Produkts während des normalen Gebrauchs des Produkts gemäß den Anweisungen des Benutzerhandbuchs nicht die im Benutzerhandbuch genannte empfohlene Helligkeit aufrecht erhalten können.

Die Dauer der Garantieleistung beträgt fünf (5) Jahre ab dem Kaufdatum des Produkts (im Weiteren als „**Garantiefrist**“ bezeichnet), wobei vorausgesetzt wird, dass die Helligkeit des Produkts nur garantiert wird, wenn das Produkt innerhalb der empfohlenen Helligkeit, wie im Benutzerhandbuch beschrieben, verwendet wird, und die Dauer der Garantiefrist für die Helligkeit beträgt fünf (5) Jahre ab dem Kaufdatum des Produkts, wobei die Nutzungszeit des Produkts auf maximal 20.000 Betriebsstunden (bei einer Helligkeit von 400 cd/m² und einer Farbtemperatur von 7500 K) oder maximal 30.000 Betriebsstunden (bei einer Helligkeit von 300 cd/m² und einer Farbtemperatur von 7500 K) beschränkt ist. EIZO und die Vertriebe übernehmen über den Rahmen dieser Garantie hinaus hinsichtlich des Produkts keinerlei Haftung oder Verpflichtung dem Erstkäufer oder Dritten gegenüber.

EIZO und die Vertriebe verpflichten sich, Ersatzteile für das Produkt über einen Zeitraum von sieben (7) Jahren nach Einstellung der Produktion der Ersatzteile zu lagern bzw. anzubieten. EIZO und seine Vertriebspartner verpflichten sich, bei einer etwaigen Reparatur des Monitors ausschließlich Produkte gemäß den EIZO-Qualitätssicherungsstandards zu verwenden.

Diese Garantie gilt nur in Ländern oder Gebieten, in denen sich Vertriebe befinden. Die gesetzlichen Gewährleistungsrechte des Erstkäufers gegenüber dem Verkäufer werden durch diese Garantie nicht berührt.

EIZO und die Vertriebe besitzen im Rahmen dieser Garantie keinerlei Verpflichtung in den folgenden Fällen:

- (a) Produktdefekte, die auf Frachtschäden, Modifikation, Nachgestaltung, Missbrauch, Fehlbedienung, Unfälle, unsachgemäße Installation, Naturkatastrophen, fehlerhafte Wartung und/oder unsachgemäße Reparatur durch eine andere Partei als EIZO und die Vertriebe zurückzuführen sind.
- (b) Eine Inkompatibilität des Produkts aufgrund von technischen Neuerungen und/oder neuen Bestimmungen, die nach dem Kauf in Kraft treten.
- (c) Jegliche Verschlechterung des Sensors;
- (d) Jegliche Verschlechterung der Bildschirmleistung, die durch Verschleißteile wie den LCD-Panel und/oder die Hintergrundbeleuchtung usw. hervorgerufen werden (z.B. Veränderungen von Farbe oder Farbverteilung, Pixeldefekte einschließlich von durchgebrannten Pixeln usw.).
- (e) Jegliche Abnutzung des Produkts, die auf einen Gebrauch mit einer höheren Helligkeit als die im Benutzerhandbuch genannte empfohlene Helligkeit zurückzuführen ist.
- (f) Produktdefekte, die durch externe Geräte verursacht werden.
- (g) Jeglicher Defekt eines Produkts, dessen ursprüngliche Seriennummer geändert oder entfernt wurde.
- (h) Normale Abnutzung des Produkts, insbesondere von Verbrauchsteilen, Zubehörteilen und/oder Beilagen (z.B. Tasten, drehbare Teile, Kabel, Benutzerhandbuch usw.); sowie
- (i) Verformungen, Verfärbungen und/oder Verziehungen am Produktäußeren, einschließlich der Oberfläche des LCD-Panels.

Bei Inanspruchnahme der Garantieleistung ist der Erstkäufer verpflichtet, das Produkt auf eigene Kosten und in der Originalverpackung bzw. einer anderen geeigneten Verpackung, die einen gleichwertigen Schutz gegen Transportschäden bietet, an den örtlichen Vertrieb zu übersenden, wobei der Erstkäufer das Transportrisiko gegenüber Schäden und/oder Verlust trägt. Zum Zeitpunkt der Inanspruchnahme der Garantieleistung muss der Erstkäufer einen Verkaufsbeleg vorweisen, auf dem das Kaufdatum angegeben ist.

Die Garantiefrist für ein im Rahmen dieser Garantie ausgetauschtes und/oder repariertes Produkt erlischt nach Ablauf der ursprünglichen Garantiefrist.

EIZO ODER DIE EIZO-VERTRAGSIMPORTEURE HAFTEN NICHT FÜR ZERSTÖRTE DATENBESTÄNDE ODER DIE KOSTEN DER WIEDERBESCHAFFUNG DIESER DATENBESTÄNDE AUF JEDLICHEN DATENTRÄGERN ODER TEILEN DES PRODUKTS, DIE IM RAHMEN DER GARANTIE BEI EIZO ODER DEN EIZO-VERTRAGSIMPORTEUREN ZUR REPARATUR EINGEREICHT WURDEN.

EIZO UND DIE EIZO-VERTRAGSIMPORTEURE GEBEN WEDER EXPLIZITE NOCH IMPLIZITE GARANTIEEN IN BEZUG AUF DIESES PRODUKT UND SEINE QUALITÄT, LEISTUNG, VERKÄUFLICHKEIT ODER EIGNUNG FÜR EINEN BESTIMMTEN ZWECK. AUF KEINEN FALL SIND EIZO ODER DIE EIZO-VERTRAGSIMPORTEURE VERANTWORTLICH FÜR JEDLICHE ZUFÄLLIGE, INDIREKTE, SPEZIELLE, FOLGE- ODER ANDERE SCHÄDEN JEDLICHER ART (EINSCHLIESSLICH OHNE JEDE BEGRENZUNG SCHÄDEN BEZÜGLICH PROFITVERLUST, GESCHÄFTSUNTERBRECHUNG, VERLUST VON GESCHÄFTSINFORMATION ODER JEDLICHE ANDEREN FINANZIELLEN EINBUSSEN), DIE DURCH DIE VERWENDUNG DES PRODUKTES ODER DIE UNFÄHIGKEIT ZUR VERWENDUNG DES PRODUKTES ODER IN JEDLICHER BEZIEHUNG MIT DEM PRODUKT, SEI ES BASIEREND AUF VERTRAG, SCHADENSERSATZ, NACHLAESSIGKEIT, STRIKTE HAFTPFLICHT ODER ANDEREN FORDERUNGEN ENTSTEHEN, AUCH WENN EIZO UND DIE EIZO-VERTRAGSIMPORTEURE IM VORAUS ÜBER DIE MÖGLICHKEIT SOLCHER SCHÄDEN INFORMIERT WURDEN. DIESER AUSSCHLUSS ENTHÄLT AUCH JEDE HAFTPFLICHT, DIE AUS FORDERUNGEN DRITTER GEGEN DEN ERSTKÄUFER ENTSTEHEN KANN. ZWECK DIESER KLAUSEL IST ES, DIE HAFTUNG VON EIZO UND DEN VERTRIEBEN GEGENÜBER FORDERUNGEN ZU BEGRENZEN, DIE AUS DIESER BESCHRÄNKTEN GARANTIE UND/ODER DEM VERKAUF ENTSTEHEN KÖNNEN.

GARANTIE LIMITÉE

EIZO Corporation (ci-après dénommé « **EIZO** ») et les distributeurs autorisés par EIZO (ci-après dénommés « **Distributeurs** »), sous réserve et conformément aux termes de cette garantie limitée (ci-après dénommée « **Garantie** »), garantissent à l'acheteur initial (ci-après dénommé « **Acheteur initial** ») du produit spécifié dans la présente (ci-après dénommé « **Produit** ») acheté auprès d'EIZO ou de Distributeurs agréés EIZO, que EIZO et ses Distributeurs auront pour option de réparer ou remplacer gratuitement le Produit si l'Acheteur initial constate, pendant la Période de garantie (définie ci-dessous), (i) qu'il y a un dysfonctionnement ou que le Produit a subi un dommage dans le cadre d'une utilisation normale du Produit conformément à la description du mode d'emploi qui accompagne le Produit (ci-après dénommé « **Manuel d'utilisateur** »), ou (ii) que le panneau LCD et la luminosité du Produit ne peuvent pas maintenir la luminosité recommandée spécifiée dans le Manuel d'utilisation dans le cadre d'une utilisation normale du Produit, conformément à la description du Manuel d'utilisation.

La période de cette Garantie est limitée à cinq (5) ans à partir de la date d'achat du Produit (ci-après dénommée « Période de Garantie »), sous réserve que la luminosité du Produit ne sera garantie que si le Produit a été utilisé conformément à la luminosité recommandée dans le Manuel d'Utilisation et la Période de Garantie en matière de luminosité est limitée à cinq (5) ans à compter de la date d'achat du Produit, sous réserve que la durée d'utilisation soit inférieure ou égale à 20 000 heures (la luminosité est de 400 cd/m² et la température de la couleur à 7500 K) ou inférieure ou égale à 30 000 heures (la luminosité est de 300 cd/m² et la température de la couleur à 7500 K). EIZO et ses Distributeurs déclinent toute responsabilité ou obligation concernant ce Produit face à l'Acheteur initial ou à toute autre personne à l'exception de celles stipulées dans la présente Garantie.

EIZO et ses Distributeurs cesseront de tenir ou conserver en stock toute pièce de ce Produit après l'expiration de la période de sept (7) ans suivant l'arrêt de la production de telles pièces. Pour réparer le moniteur, EIZO et ses distributeurs utiliseront des pièces de rechange conformes à nos normes de contrôle qualité.

La Garantie est valable uniquement dans les pays ou les territoires où se trouvent les Distributeurs. La Garantie ne limite aucun des droits reconnus par la loi à l'Acheteur initial.

Nonobstant toute autre clause de cette Garantie, EIZO et ses Distributeurs n'auront d'obligation dans le cadre de cette Garantie pour aucun des cas énumérés ci-dessous :

- (a) Tout défaut du Produit résultant de dommages occasionnés lors du transport, d'une modification, d'une altération, d'un abus, d'une mauvaise utilisation, d'un accident, d'une installation incorrecte, d'un désastre, d'un entretien et/ou d'une réparation incorrects effectués par une personne autre que EIZO ou ses Distributeurs ;
- (b) Toute incompatibilité du Produit résultant d'améliorations techniques et/ou réglementations possibles ;
- (c) Toute détérioration du capteur ;
- (d) Toute détérioration des performances d'affichage causée par la détérioration des éléments consommables tels que le panneau LCD et/ou le rétroéclairage, etc. (par exemple, des changements de couleur, des changements de l'uniformité des couleurs, des défauts de pixels, y compris des pixels brûlés, etc.) ;
- (e) Toute détérioration du Produit causée par l'utilisation d'une luminosité plus élevée que la luminosité recommandée, telle que décrite dans le Manuel d'utilisation ;
- (f) Tout défaut du Produit causé par un appareil externe ;
- (g) Tout défaut d'un Produit sur lequel le numéro de série original a été altéré ou supprimé ;
- (h) Toute détérioration normale du Produit, particulièrement celle des consommables, des accessoires et/ou des pièces reliées au Produit (touches, éléments pivotants, câbles, Manuel d'utilisation etc.), et
- (i) Toute déformation, décoloration, et/ou gondolage de l'extérieur du Produit, y compris celle de la surface du panneau LCD.

Pour bénéficier d'un service dans le cadre de cette Garantie, l'Acheteur initial doit renvoyer le Produit port payé, dans son emballage d'origine ou tout autre emballage approprié offrant un degré de protection équivalent, au Distributeur local, et assumera la responsabilité des dommages et/ou perte possibles lors du transport. L'Acheteur initial doit présenter une preuve d'achat du Produit comprenant sa date d'achat pour bénéficier de ce service dans le cadre de la Garantie.

La Période de garantie pour tout Produit remplacé et/ou réparé dans le cadre de cette Garantie expirera à la fin de la Période de garantie initiale.

EIZO OU SES DISTRIBUTEURS NE SAURAIENT ÊTRE TENUS RESPONSABLES DES DOMMAGES OU PERTES DE DONNÉES OU D'AUTRES INFORMATIONS STOCKÉES DANS UN MÉDIA QUELCONQUE OU UNE AUTRE PARTIE DU PRODUIT RENVOYÉ À EIZO OU AUX DISTRIBUTEURS POUR RÉPARATION.

AUCUNE AUTRE GARANTIE, EXPLICITE OU TACITE, N'EST OFFERTE PAR EIZO ET SES DISTRIBUTEURS CONCERNANT LE PRODUIT ET SES QUALITÉS, PERFORMANCES, QUALITÉ MARCHANDE OU ADAPTATION À UN USAGE PARTICULIER. EN AUCUN CAS, EIZO OU SES DISTRIBUTEURS NE SERONT RESPONSABLES DES DOMMAGES FORTUITS, INDIRECTS, SPÉCIAUX, INDUITS, OU DE TOUT AUTRE DOMMAGE QUEL QU'IL SOIT (Y COMPRIS, SANS LIMITATION, LES DOMMAGES RÉSULTANT D'UNE PERTE DE PROFIT, D'UNE INTERRUPTION D'ACTIVITÉS, D'UNE PERTE DE DONNÉES COMMERCIALES, OU DE TOUT AUTRE MANQUE À GAGNER) RÉSULTANT DE L'UTILISATION OU DE L'INCAPACITÉ D'UTILISER LE PRODUIT OU AYANT UN RAPPORT QUELCONQUE AVEC LE PRODUIT, QUE CE SOIT SUR LA BASE D'UN CONTRAT, D'UN TORT, D'UNE NÉGLIGENCE, D'UNE RESPONSABILITÉ STRICTE OU AUTRE, MÊME SI EIZO OU SES DISTRIBUTEURS ONT ÉTÉ AVERTIS DE LA POSSIBILITÉ DE TELS DOMMAGES. CETTE LIMITATION INCLUT AUSSI TOUTE RESPONSABILITÉ QUI POURRAIT ÊTRE SOULEVÉE LORS DES RÉCLAMATIONS D'UN TIERS CONTRE L'ACHETEUR INITIAL. L'ESSENCE DE CETTE CLAUSE EST DE LIMITER LA RESPONSABILITÉ POTENTIELLE DE EIZO ET DE SES DISTRIBUTEURS RÉSULTANT DE CETTE GARANTIE LIMITÉE ET/OU DES VENTES.

GARANTÍA LIMITADA

EIZO Corporation (en lo sucesivo “EIZO”) y sus distribuidores autorizados por EIZO (en lo sucesivo los “Distribuidores”), con arreglo y de conformidad con los términos de esta garantía limitada (en lo sucesivo la “Garantía”), garantizan al comprador original (en lo sucesivo el “Comprador original”) que compró el producto especificado en este documento (en lo sucesivo el “Producto”) a EIZO o a sus Distribuidores, que EIZO y sus Distribuidores, a su propio criterio, repararán o sustituirán el Producto de forma gratuita si el Comprador original detecta dentro del periodo de la Garantía (indicado posteriormente) que: (i) el Producto no funciona correctamente o que se ha averiado durante el uso normal del mismo de acuerdo con las indicaciones del manual de instrucciones suministrado con el Producto (en lo sucesivo el “Manual del usuario”); o (ii) el panel LCD y el brillo del Producto no pueden mantener el brillo recomendado que se especifica en el Manual del usuario durante el uso normal del Producto de acuerdo con las descripciones del Manual del usuario.

El período de validez de esta Garantía es de cinco (5) años a contar desde la fecha de compra del Producto (en adelante, “Período de garantía”), teniendo en cuenta que el brillo del Producto sólo estará cubierto por la garantía si el Producto se ha utilizado con el brillo recomendado que se describe en el Manual del usuario, y que el Período de garantía está limitado a cinco (5) años a partir de la fecha de compra del Producto, siempre que el tiempo de uso sea inferior o igual a 20.000 horas (siendo el brillo de 400cd/m² y la temperatura de color de 7500K) o inferior o igual a 30.000 horas (siendo el brillo de 300cd/m² y la temperatura de color de 7500K). EIZO y sus Distribuidores no tendrán ninguna responsabilidad ni obligación con respecto al Producto para con el Comprador original ni con terceros que no sean las estipuladas en la presente Garantía.

EIZO y sus Distribuidores no estarán obligados a suministrar cualquier recambio del Producto una vez pasados siete (7) años desde que se deje de fabricar el mismo. Para la reparación del monitor, EIZO y los distribuidores utilizarán repuestos que cumplan con nuestros estándares de control de calidad.

La Garantía es válida sólo en los países y territorios donde están ubicados los Distribuidores. La Garantía no restringe ningún derecho legal del Comprador original.

A pesar de las estipulaciones de esta Garantía, EIZO y sus Distribuidores no tendrán obligación alguna bajo esta Garantía en ninguno de los casos expuestos a continuación:

- (a) Cualquier defecto del Producto causado por daños en el transporte, modificación, alteración, abuso, uso incorrecto, accidente, instalación incorrecta, desastre, mantenimiento incorrecto y/o reparación indebida realizada por un tercero que no sea EIZO o sus Distribuidores.
- (b) Cualquier incompatibilidad del Producto debida a posibles innovaciones técnicas y/o reglamentaciones.
- (c) Cualquier deterioro del sensor;
- (d) Cualquier deterioro en el rendimiento de la visualización causado por fallos en las piezas consumibles como el panel de cristal líquido y/o la luz de fondo, etc. (p.ej. cambios de color, cambios de uniformidad del color, defectos de píxeles, incluyendo píxeles muertos, etc.).
- (e) Cualquier deterioro del Producto causado por el uso continuado con un brillo superior al recomendado en el Manual del usuario.
- (f) Cualquier defecto del Producto causado por un equipo externo.
- (g) Cualquier defecto del Producto en el que haya sido alterado o borrado el número de serie original.
- (h) Cualquier deterioro normal del Producto, y en particular de las piezas consumibles, accesorios y demás (p. ej. botones, piezas giratorias, cables, Manual del usuario, etc.).
- (i) Cualquier deformación, decoloración y/o alabeo del exterior del Producto incluida la superficie del panel LCD.

Para obtener servicio en los términos de esta Garantía, el Producto deberá ser enviado por el Comprador original, a su Distribuidor local, con el transporte previamente pagado, en el embalaje original u otro embalaje adecuado que ofrezca el mismo grado de protección, asumiendo el riesgo de daños y/o pérdida del Producto durante el transporte. El Comprador original deberá presentar un comprobante de compra del Producto en el que se refleje la fecha de compra del mismo cuando lo solicite el servicio de Garantía.

El Período de garantía para cualquier Producto reemplazado y/o reparado en los términos de esta Garantía expirará al vencer el Período de garantía original.

EIZO O LOS DISTRIBUIDORES AUTORIZADOS DE EIZO NO SE RESPONSABILIZAN DE NINGÚN DAÑO O PÉRDIDA QUE PUEDAN SUFRIR LOS DATOS U OTRA INFORMACIÓN ALMACENADA EN CUALQUIER MEDIO O CUALQUIER PARTE DE CUALQUIER PRODUCTO DEVUELTO A EIZO O A LOS DISTRIBUIDORES DE EIZO PARA SU REPARACIÓN.

EIZO Y LOS DISTRIBUIDORES AUTORIZADOS DE EIZO NO OFRECEN NINGUNA OTRA GARANTÍA, IMPLÍCITA NI EXPLÍCITA, CON RESPECTO AL PRODUCTO Y A SU CALIDAD, RENDIMIENTO, COMERCIALIZACIÓN E IDONEIDAD PARA CUALQUIER USO EN PARTICULAR. EN NINGÚN CASO SERÁN EIZO O LOS DISTRIBUIDORES AUTORIZADOS DE EIZO RESPONSABLES DE NINGÚN DAÑO EMERGENTE, INDIRECTO, ESPECIAL, INHERENTE O CUALQUIERA QUE SEA (INCLUYENDO, SIN LIMITACIÓN, DAÑOS POR LUCRO CESANTE, INTERRUPCIÓN DE LA ACTIVIDAD COMERCIAL, PÉRDIDA DE INFORMACIÓN COMERCIAL O CUALQUIER OTRA PÉRDIDA PECUNIARIA) QUE SE DERIVE DEL USO O IMPOSIBILIDAD DE USO DEL PRODUCTO O EN RELACIÓN CON EL PRODUCTO, YA SEA BASADO EN CONTRATO, POR AGRAVIO, NEGLIGENCIA, ESTRICTA RESPONSABILIDAD O CUALQUIERA QUE SEA, AUN CUANDO SE HAYA ADVERTIDO A EIZO O A LOS DISTRIBUIDORES DE EIZO DE LA POSIBILIDAD DE TALES DAÑOS. ESTA EXCLUSIÓN TAMBIÉN ABARCA CUALQUIER RESPONSABILIDAD QUE PUEDA DERIVARSE DE RECLAMACIONES HECHAS POR UN TERCERO CONTRA EL COMPRADOR ORIGINAL. LA ESENCIA DE ESTA ESTIPULACIÓN ES LIMITAR LA RESPONSABILIDAD POTENCIAL DE EIZO Y LOS DISTRIBUIDORES QUE PUDIERA DERIVARSE DE ESTA GARANTÍA LIMITADA Y/O VENTAS.

GARANZIA LIMITATA

EIZO Corporation (a cui si farà riferimento da qui in poi con “**EIZO**”) ed i Distributori autorizzati da EIZO (a cui si farà riferimento da qui in poi con “**Distributori**”) garantiscono, secondo i termini di questa garanzia limitata (a cui si farà riferimento da qui in poi con “**Garanzia**”) all’acquirente originale (a cui si farà riferimento da qui in poi con “**Acquirente originale**”) che ha acquistato il prodotto specificato in questo documento (a cui si farà riferimento da qui in poi con “**Prodotto**”) da EIZO o dai suoi Distributori, che EIZO e i distributori, a loro discrezione, ripareranno o sostituiranno il Prodotto senza addebito se l’Acquirente originale trova, entro il periodo della Garanzia (definito sotto), che (i) il Prodotto malfunziona e si è danneggiato nel corso del suo normale utilizzo osservando le indicazioni del manuale di istruzioni allegato al Prodotto (a cui si farà riferimento da qui in poi con “**Manuale utente**”), o che (ii) il pannello LCD e la luminosità del Prodotto non possono mantenere la luminosità raccomandata specificata nel Manuale utente nel corso del normale utilizzo del Prodotto osservando le indicazioni del Manuale utente.

La presente Garanzia ha una validità di cinque (5) anni dalla data dell’acquisto del Prodotto (di qui in avanti “Periodo di Garanzia”), considerando che la luminosità del Prodotto sarà garantita solo se il Prodotto è stato utilizzato con la luminosità consigliata descritta nel Manuale utente e che il Periodo di garanzia per la luminosità è limitato a cinque (5) anni dalla data di acquisto del Prodotto, a condizione che il tempo di utilizzo sia inferiore o uguale a 20.000 ore (luminosità di 400cd/m² e temperatura colore di 7.500K) o inferiore o uguale a 30.000 ore (luminosità di 300cd/m² e temperatura colore di 7.500K). EIZO e i suoi Distributori non si assumono alcuna responsabilità e non hanno alcun obbligo riguardo al Prodotto verso l’Acquirente originale o terzi diversi da quelli relativi a questa Garanzia.

EIZO e i suoi Distributori cesseranno di tenere o di conservare qualsiasi ricambio del Prodotto allo scadere di sette (7) anni dopo che la produzione di tali ricambi è stata terminata. Per la riparazione del monitor, EIZO e i Distributori utilizzeranno parti di ricambio conformi ai nostri standard di controllo della qualità.

La Garanzia è valida soltanto nei paesi dove ci sono i Distributori EIZO. La Garanzia non limita alcun diritto legale dell’Acquirente originale.

Indipendentemente da qualsiasi altra condizione di questa Garanzia, EIZO e i suoi Distributori non avranno alcun obbligo derivante da questa Garanzia in ognuno dei casi elencati di seguito:

- (a) Qualsiasi difetto del Prodotto causato da danni di trasporto, modifiche, alterazioni, abusi, usi impropri, incidenti, installazione errata, calamità, manutenzione errata e/o riparazioni improprie eseguite da terze parti che non siano EIZO o i suoi Distributori.
- (b) Qualsiasi incompatibilità del Prodotto dovuta a possibili innovazioni tecniche e/o normative.
- (c) Qualsiasi deterioramento del sensore;
- (d) Qualsiasi deterioramento delle prestazioni dello schermo causato dal deterioramento delle parti consumabili, come il pannello LCD e/o la retroilluminazione, ecc. (per esempio: i cambiamenti di colore, cambiamenti di uniformità del colore, difetti dei pixel, inclusi i pixel bruciati, ecc.).
- (e) Qualsiasi deterioramento del Prodotto causato dal suo utilizzo ad una luminosità più alta di quella raccomandata nel Manuale utente.
- (f) Qualsiasi difetto del Prodotto causato da apparecchiature esterne.
- (g) Qualsiasi difetto del Prodotto in cui il numero di serie originale sia stato alterato o rimosso.
- (h) Qualsiasi normale deterioramento del Prodotto, in particolar modo nelle sue parti di consumo, accessori, e/o attacchi (per esempio: tasti, parti rotanti, cavi, Manuale dell’utente, ecc.).
- (i) Qualsiasi tipo di deformazione, scolorimento, e/o di involucro esterno del Prodotto inclusa la superficie del pannello LCD.

Per ricevere assistenza tecnica con questa Garanzia, l’Acquirente originale deve inviare il Prodotto, con trasporto pre-pagato, nella sua confezione originale o altra confezione adeguata che fornisce un livello analogo di protezione, assumendosi il rischio di danni e/o perdita in transito, al Distributore locale. L’Acquirente originale deve presentare la prova di acquisto che stabilisce la data di acquisto del Prodotto quando richiede servizio sotto Garanzia.

Il Periodo di garanzia per qualsiasi Prodotto sostituito e/o riparato sotto questa Garanzia scade alla fine del Periodo di garanzia originale.

EIZO O I SUOI DISTRIBUTORI NON SONO RESPONSABILI PER QUALSIASI DANNO O PERDITA DI DATI O ALTRE INFORMAZIONI MEMORIZZATI SU QUALSIASI SUPPORTO O QUALSIASI PARTE DI QUALSIASI PRODOTTO INVIATO A EIZO O I SUOI DISTRIBUTORI PER RIPARAZIONI.

EIZO E I SUOI DISTRIBUTORI NON OFFRONO ALCUNA GARANZIA ADDIZIONALE, IMPLICITA O ESPLICITA, RIGUARDO IL PRODOTTO E LA SUA QUALITÀ, PRESTAZIONI, VENDIBILITÀ O APPROPRIATEZZA PER QUALSIASI USO PARTICOLARE. IN NESSUN CASO EIZO O I DISTRIBUTORI EIZO AUTORIZZATI SARANNO RESPONSABILI PER QUALSIASI DANNO ACCIDENTALE, INDIRETTO, SPECIALE, CONSEGUENTE O DI QUALSIASI ALTRA NATURA (INCLUSI, SENZA LIMITI, DANNI PER PERDITA DI PROFITTI, INTERRUZIONE DELLE ATTIVITÀ, PERDITA DI INFORMAZIONI D’AFFARI O QUALSIASI ALTRA PERDITA PECUNIARIA) DERIVANTI DALL’USO O DALL’IMPOSSIBILITÀ DI USARE IL PRODOTTO O IN QUALSIASI RELAZIONE AL PRODOTTO, SIA SU BASE DI CONTRATTO, TORTO, NEGLIGENZA, STRETTA RESPONSABILITÀ O ALTRIMENTI, ANCHE SE EIZO O I DISTRIBUTORI EIZO AUTORIZZATI SONO STATI AVVERTITI DELLA POSSIBILITÀ DI TALI DANNI. QUESTA ESCLUSIONE INCLUDE ANCHE QUALSIASI RESPONSABILITÀ CHE POSSA INSORGERE DA RECLAMI DI TERZI CONTRO L’ACQUIRENTE ORIGINALE. L’ESSENZA DI QUESTO PROVVEDIMENTO È LIMITARE LA RESPONSABILITÀ POTENZIALE DI EIZO E DEI DISTRIBUTORI DERIVANTE DA QUESTA GARANZIA LIMITATA E/O DALLE VENDITE.

BEGRÄNSAD GARANTI

EIZO Corporation (nedan kallat "**EIZO**") och EIZOs auktoriserade distributörer (nedan kallade "**Distributörer**") garanterar i enlighet med villkoren i denna begränsade garanti (nedan kallad "**Garantin**") den ursprunglige köparen (nedan kallad den "**Ursprunglige köparen**") som köpte den i dokumentet specificerade produkten (nedan kallad "**Produkten**") från EIZO eller Distributörer, att EIZO eller Distributörer enligt eget gottfinnande kostnadsfritt antingen reparera eller byta ut den defekta Produkten om den Ursprunglige köparen inom Garantiperioden (definieras nedan) upptäcker att (i) Produkten fungerar felaktigt eller skadas under normal användning av Produkten i enlighet med beskrivningen i bruksanvisningen (nedan kallad "**Bruksanvisning**") eller att (ii) Produktens LCD-panel och ljusstyrka inte kan bibehålla den rekommenderade ljusstyrkan som anges i Bruksanvisningen under normal användning av Produkten i enlighet med beskrivningen i Bruksanvisningen.

Giltighetsperioden för denna garanti är fem (5) år från produktens inköpsdatum (kallas härefter "Garantiperioden"), förutsatt att ljusstyrkan på produkten är garanterad endast om produkten har använts inom den rekommenderade ljusstyrka som beskrivs i Användarmanualen och Garantiperioden för ljusstyrkan är begränsad till fem (5) år från produktens inköpsdatum såvida användningstiden är mindre än eller lika med 20 000 timmar (ljusstyrkan är 400cd/m² och färgtemperaturen är 7 500K) eller mindre än eller lika med 30 000 timmar (ljusstyrkan är 300cd/m² och färgtemperaturen är 7 500K). EIZO och Distributörer ska inte under några villkor ha något annat ansvar än vad som anges i denna garanti gällande Produkten i relation till den Ursprunglige köparen eller tredje part.

EIZO och Distributörer kommer att upphöra med lagerhållning av Produktens delar efter sju (7) år efter att produktionen av dessa delar upphört. Nät skärmen repareras använder EIZO och distributörer reservdelar som uppfyller våra kvalitetsstandarder.

Garantin är endast giltig i de länder där det finns Distributörer. Garantin begränsar inte några av den Ursprunglige köparens lagstadgade rättigheter.

Oavsett andra villkor i denna garanti ska inte EIZO Distributörer under några villkor ha något ansvar i något av de fall som beskrivs nedan:

- (a) När någon bristfällighet hos Produkten kan härledas till att ha uppstått vid frakt, modifiering, ändring, felaktigt handhavande, olycka, felaktig installation, katastrof, felaktigt underhåll och/eller felaktig reparation utförd av tredje part annan än EIZO och Distributörer.
- (b) Alla former av inkompatibilitet hos Produkten på grund av möjliga tekniska innovationer och/eller bestämmelser.
- (c) Alla försämringar av sensorn;
- (d) Alla försämringar av bildens prestanda beroende på förbrukningsdelar så som LCD-panel och/eller bakgrundsbelysning etc. (t.ex. förändringar i färg, färgjämnhet, defekta pixlar inklusive brända pixlar etc.).
- (e) Alla försämringar av Produkten orsakat av användning av en högre ljusstyrka än den i Bruksanvisningen rekommenderade ljusstyrkan.
- (f) Alla defekter hos Produkten som orsakats av extern utrustning.
- (g) Alla defekter hos Produkten på vilken det ursprungliga serienumret har ändrats eller avlägsnats.
- (h) All normal försämring av Produkten, speciellt förbrukningsartiklar, tillbehör och/eller yttre delar (t.ex. knappar, roterande delar, kablar, Bruksanvisningen etc.).
- (i) Varje deformation, missfärgning och/eller skevhet av Produktens yttre inklusive ytan på LCD-panelen.

För att erhålla service under denna garanti måste den Ursprunglige köparen (med hänseende till risken för skada och/eller förlust under transport) leverera Produkten till närmaste Distributör med förebetald frakt, i dess ursprungliga förpackning eller annan fullgod förpackning som ger likvärdigt skydd. Den Ursprunglige köparen måste kunna visa inköpsbevis för Produkten som klagör Produktens inköpsdatum vid begäran av garantiservice.

Garantiperioden för alla utbytta och/eller reparerade produkter under denna garanti skall upphöra vid utgången av den ursprungliga Garantiperioden.

EIZO ELLER DISTRIBUTÖRER ÄR INTE ANSVARIGA FÖR NÅGON FORM AV SKADA ELLER FÖRLUST AV DATA ELLER ANNAN INFORMATION SOM HAR LAGRATS I NÅGON FORM AV MEDIA ELLER ANNAN DEL AV NÅGON PRODUKT SOM HAR RETURNERATS TILL EIZO ELLER DISTRIBUTÖRER FÖR REPARATION.

EIZO OCH DISTRIBUTÖRERNA GARANTERAR INGET, UTTRYCKLIGEN ELLER UNDERFÖRSTÅTT, VAD BETRÄFFAR PRODUKTEN OCH DESS KVALITET, PRESTANDA, SÄLJBARHET ELLER LÄMPLIGHET FÖR NÅGON FORM AV SPECIELL ANVÄNDNING. UNDER INGA OMSTÄNDIGHETER SKALL EIZO ELLER DISTRIBUTÖRERNA HÅLLAS ANSVARIGA FÖR NÅGRA SOM HELST UNDERORDNADE, INDIREKTA, SPECIELLA, DÄRAV FÖLJANDE ELLER ÖVRIGA SKADOR (INKLUSIVE, UTAN BEGRÄNSNING TILL, SKADOR FÖR FÖRLUST AV INKOMST, AVBRUTEN AFFÄRSRÖRELSE, FÖRLUST AV AFFÄRSINFORMATION ELLER ANNAN SÄRSKILD FÖRLUST) SOM UPPSTÅTT SOM ETT RESULTAT AV ANVÄNDNING ELLER OFÖRMÅGA ATT ANVÄNDA PRODUKTEN ELLER I NÅGON FORM AV ANSLUTNING TILL PRODUKTERNA, VARE SIG DETTA GRUNDAS PÅ KONTRAKT, ÅTALBAR HANDLING, FÖRSUMLIGHET, ANSVARSSKYLDIGHET ELLER ANNAT, ÄVEN OM EIZO ELLER DISTRIBUTÖRERNA HAR INFORMERATS BETRÄFFANDE MÖJLIGHET ATT SÅDANA SKADOR FÖRELIGGER. DETTA UNDANTAG OMFATTAR ÄVEN ALL FORM AV ANSVARSSKYLDIGHET SOM KAN UPPSTÅ GENOM EN TREDJE PARTS ANSPRÅK GENTEMOT DEN URSPRUNGLIGE KÖPAREN. GRUNDBESTÄNDSDELEN I BESTÄMMELEN ÄR ATT BEGRÄNSA DET EVENTUELLA ANSVARSTAGANDET FÖR EIZO OCH DISTRIBUTÖRERNA SOM KAN UPPSTÅ GENOM DENNA BEGRÄNSADE GARANTI OCH/ELLER FÖRSÄLJNING.

ОГРАНИЧЕННАЯ ГАРАНТИЯ

EIZO Corporation (называемая в дальнейшем “EIZO”) и авторизованные EIZO дистрибуторы (называемые в дальнейшем “Дистрибуторы”) гарантируют, в соответствии с условиями и пунктами этой ограниченной гарантии (называемой в дальнейшем “Гарантия”), первичному покупателю (называемому в дальнейшем “Первоначальный покупатель”), который приобрел у EIZO или Дистрибуторов продукт, указанный в этом документе (называемый в дальнейшем “Продукт”), что EIZO или Дистрибуторы на свое усмотрение либо бесплатно отремонтируют, либо бесплатно заменят Продукт, если Первоначальный покупатель признает в пределах Гарантийного срока (определенного ниже), что (i) Продукт неисправен или он поврежден в процессе нормального использования Продукта в соответствии с описанием в инструкции по эксплуатации, прилагаемой к Продукту (называемой в дальнейшем “Руководство пользователя”), или что (ii) панель ЖКД и Яркость Продукта не в состоянии поддерживать рекомендованную яркость, указанную в Руководстве пользователя при условии нормального использования Продукта в соответствии с описанием в Руководстве пользователя.

Гарантийный период (называемый в дальнейшем «Гарантийный период») ограничен сроком пять (5) лет со дня приобретения Продукта. Яркость Продукта может быть гарантирована только в том случае, если Продукт использовался с рекомендованной яркостью, указанной в Руководстве пользователя; Гарантийный период в отношении яркости ограничен периодом пять (5) лет со дня приобретения Продукта при условии, что время его использования не превышает 20 000 часов (для яркости 400 Кд/м² и цветовой температуры 7500 К) или 30 000 часов (для яркости 300 Кд/м² и цветовой температуры 7500 К). EIZO и Дистрибуторы не несут никакой ответственности и не берут обязательств относительно Продукта по отношению к Первоначальному покупателю или по отношению к любым третьим сторонам, кроме обязательств, оговоренных в этой Гарантии.

EIZO и Дистрибуторы прекратят хранение или складирование любых деталей Продукта по истечении семи (7) лет после прекращения производства таких деталей. В случае ремонта монитора EIZO и Дистрибуторы будут использовать запчасти, которые соответствуют нашим стандартам QC (контроль качества).

Гарантия действительна только в странах или регионах, где расположены Дистрибуторы. Гарантия не ограничивает никакие законные права Первоначального покупателя.

Несмотря на другие условия этой Гарантии EIZO и Дистрибуторы не несут никаких обязательств согласно этой Гарантии в любом из перечисленных ниже случаев:

- (а) Любые дефекты Продукта, вызванные повреждениями при перевозке, модификацией, изменением, неправильным обращением, неправильным использованием, авариями, неправильной установкой, стихийными бедствиями, неправильным уходом и/или неправильным ремонтом третьей стороной, отличной от EIZO или Дистрибуторов;
- (б) Любые несовместимости Продукта из-за технических усовершенствований и/или изменения технических норм;
- (в) Любое повреждение датчика;
- (г) Любое ухудшение качества изображения, вызванное устареванием изнашивающихся частей, таких как ЖК-панель и/или задняя подставка и т. д. (например, изменения цветопередачи, цветовой однородности, дефекты пикселей, включая сгоревшие пиксели, и т. д.);
- (д) Любые ухудшения Продукта, вызванные использованием при яркости, повышенной по сравнению с рекомендованной яркостью, описанной в Руководстве пользователя;
- (е) Любые дефекты Продукта, вызванные внешним оборудованием;
- (ж) Любые дефекты Продукта, при которых оригинальный серийный номер был изменен или удален;
- (з) Любые естественные ухудшения продукта, в частности, вызванные износом расходных частей, принадлежностей и/или приспособлений (например, кнопок, вращающихся частей, кабелей, Руководства пользователя и т.д.); и
- (и) Любые деформации, изменения цвета и/или коробления внешней поверхности продукта, включая поверхность панели ЖКД.

Чтобы получить техническое обслуживание в рамках Гарантии, Первоначальный покупатель должен доставить Продукт местному Дистрибутору, оплатив перевозку, в его оригинальной упаковке или в другой соответствующей упаковке, обеспечивающей равноценную степень защиты, принимая во внимание риск повреждения и/или утерю при транспортировке. При запросе технического обслуживания в рамках Гарантии Первоначальный покупатель должен предоставить свидетельство покупки продукта и даты покупки.

Гарантийный период для любого замененного и/или отремонтированного продукта в рамках Гарантии истекает в конце завершения срока действия оригинального Гарантийного периода.

EIZO ИЛИ ДИСТРИБУТОРЫ НЕ НЕСУТ ОТВЕТСТВЕННОСТИ ЗА ЛЮБЫЕ ПОВРЕЖДЕНИЯ ИЛИ УТЕРЮ ДАННЫХ ИЛИ ДРУГОЙ ИНФОРМАЦИИ, ХРАНЯЩИХСЯ НА КАКИХ-ЛИБО НОСИТЕЛЯХ ИНФОРМАЦИИ ИЛИ НА ЛЮБЫХ ДРУГИХ ЧАСТЯХ ПРОДУКТА, КОТОРЫЙ ВОЗВРАЩЕН EIZO ИЛИ ДИСТРИБУТОРАМ ДЛЯ РЕМОНТА.

EIZO и ДИСТРИБУТОРЫ НЕ ДАЮТ НИКАКОЙ ДАЛЬНЕЙШЕЙ ГАРАНТИИ, ВЫРАЖЕННОЙ ИЛИ ПОДРАЗУМЕВАЕМОЙ, ОТНОСИТЕЛЬНО ПРОДУКТА И ЕГО КАЧЕСТВА, ТЕХНИЧЕСКИХ ХАРАКТЕРИСТИК, ТОВАРНОСТИ ИЛИ СООТВЕТСТВИЯ ДЛЯ КАКОГО-ЛИБО ОПРЕДЕЛЕННОГО ИСПОЛЬЗОВАНИЯ. НИ ПРИ КАКИХ УСЛОВИЯХ EIZO ИЛИ ДИСТРИБУТОРЫ НЕ НЕСУТ ОТВЕТСТВЕННОСТИ ЗА ЛЮБОЙ СЛУЧАЙНЫЙ, КОСВЕННЫЙ, СПЕЦИАЛЬНЫЙ, ПОБОЧНЫЙ ИЛИ ИНОЙ УЩЕРБ (ВКЛЮЧАЯ, БЕЗ ОГРАНИЧЕНИЙ, УЩЕРБ ИЗ-ЗА НЕПОЛУЧЕННОЙ ПРИБЫЛИ, ПРЕРЫВАНИЯ БИЗНЕСА, ПОТЕРИ КОММЕРЧЕСКОЙ ИНФОРМАЦИИ ИЛИ ЛЮБЫЕ ДРУГИЕ ФИНАНСОВЫЕ ПОТЕРИ), ВОЗНИКШИЙ ИЗ-ЗА ИСПОЛЬЗОВАНИЯ ИЛИ НЕВОЗМОЖНОСТИ ИСПОЛЬЗОВАТЬ ПРОДУКТ ИЛИ В ЛЮБОЙ ДРУГОЙ СВЯЗИ С ПРОДУКТОМ, ЛИБО ОСНОВАННЫЙ НА КОНТРАКТНЫХ ОТНОШЕНИЯХ, ГРАЖДАНСКИХ ПРАВОНАРУШЕНИЯХ, НЕБРЕЖНОСТИ, ПРИЧИНИЕНИЯ УЩЕРБА ТРЕТЬЕЙ СТОРОНЕ ИЛИ ЧЕМ-ЛИБО ЕЩЕ, ДАЖЕ ЕСЛИ EIZO ИЛИ ДИСТРИБУТОРЫ БЫЛИ УВЕДОМЛЕНЫ О ВОЗМОЖНОСТИ ТАКОГО УЩЕРБА. ЭТО ИСКЛЮЧЕНИЕ ТАКЖЕ ВКЛЮЧАЕТ ЛЮБЫЕ ОБЯЗАТЕЛЬСТВА, КОТОРЫЕ МОГУТ ВОЗНИКНУТЬ В РЕЗУЛЬТАТЕ ТРЕБОВАНИЙ ТРЕТЬЕЙ СТОРОНЫ В ОТНОШЕНИИ ПЕРВОНАЧАЛЬНОГО ПОКУПАТЕЛЯ. СУЩЕСТВОМ ЭТОГО ПОЛОЖЕНИЯ ЯВЛЯЕТСЯ ОГРАНИЧЕНИЕ ПОТЕНЦИАЛЬНОЙ ОТВЕТСТВЕННОСТИ EIZO И ДИСТРИБУТОРОВ, ВОЗНИКАЮЩЕЙ ИЗ-ЗА ЭТОЙ ОГРАНИЧЕННОЙ ГАРАНТИИ И/ИЛИ ПРОДАЖ.

有限责任保证书

EIZO Corporation (以下简称“EIZO”)和 EIZO 授权的经销商 (以下简称“经销商”), 接受并依照本有限责任保证书 (以下简称“保证书”)之条款, 向从 EIZO 和经销商购买本文中规定产品 (以下简称“产品”)的原买方 (以下称“原买方”)提供保证:在保证期内 (规定如下), 如果原买方发现 (i) 按本产品所附使用说明书 (以下简称“用户手册”)所述方式正常使用本产品过程中, 本产品出现故障或损坏 或 (ii) 按用户手册所述方式正常使用本产品过程中, 本产品的液晶显示屏 (LCD) 及亮度未能达到用户手册中所述的推荐亮度时, EIZO 和经销商根据其独立的判断免费修理或更换该产品。

本保证期限定为仅按照用户手册所描述的推荐亮度使用本产品时保证其亮度的条件下自购买本产品之日起的五 (5) 年 (以下简称“保证期限”), 亮度的保证期限定为本产品的使用时间在 20000 小时以下 (含 20000 小时) (亮度为 400cd/m², 色温为开氏温度 7500) 或 30000 小时以下 (含 30000 小时) (亮度为 300cd/m², 色温为开氏温度 7500) 的条件下自购买本产品之日起五 (5) 年。EIZO 和经销商将不向原买方或任何第三方承担本保证书所规定之外的与本产品有关任何责任或义务。

本产品的任何部件停产七 (7) 年后, EIZO 和经销商将不再保留或保管任何这类部件。维修显示器时, EIZO 与经销商将使用符合我方质量控制标准的替换零件。

本保证书仅对于设有经销商的国家或地区有效。本保证书并不限定原买方的任何法律权利。

无论本保证书的任何其他条款如何规定, 对于任何下列情况之一, EIZO 和经销商将不承担本保证书规定责任:

- (a) 由于运输损害、改装、改动、滥用、误用、意外事故、错误安装、灾害、维护不善和 / 或由除 EIZO 和经销商以外的第三方进行不适当的修理造成本产品的任何故障。
- (b) 由于可能发生的技术变更和 / 或调整造成本产品的任何不兼容性。
- (c) 传感器的任何劣化;
- (d) 由于诸如液晶显示屏 (LCD) 和 / 或背景照明等消耗品部件的老化造成的任何显示性能低劣 (如色彩变化、色彩均一性变化、包括烧伤像素在内的像素缺陷等)。
- (e) 由于在比用户手册所推荐亮度更高的亮度下使用对本产品所造成的任何老化。
- (f) 因外部设备造成本产品的任何故障。
- (g) 因本产品的原序号被改变或消除造成本产品的任何故障。
- (h) 本产品的任何正常老化, 尤其是消耗品、附件和 / 或附加装置 (如按钮、旋转部件、电缆、用户手册等)、以及
- (i) 本产品表面包括液晶显示屏 (LCD) 表面的任何变形、变色和 / 翘曲。

为了获得本保证书规定的服务, 原买方必须使用原包装或其他具有同等保护程度的适当包装将本产品运送到当地的经销商, 并且预付运费, 承担运输中的损坏和 / 或损失的风险。要求提供本保证书规定的服务时, 原买方必须提交购买本产品和标明此购买日期的证明。

按本保证书规定进行了更换和 / 或修理的任何产品的保证期限, 将在原保证期限结束时终止。

在返回给 EIZO 和经销商进行修理后, 任何产品的任何媒体或任何部件中储存的数据或其他信息发生任何损坏或损失, 对此 EIZO 和经销商将不承担责任。

对于本产品及其质量、性能、可销售性以及对于特殊用途的适合性, EIZO 和经销商不提供其他任何明示或暗示的保证。因使用本产品或无法使用本产品或因与本产品有任何关系 (无论是否根据合同) 而造成:任何附带的、间接的、特殊的、随之发生的或其他的损害 (包括但不限于:利润损失、业务中断、业务信息丢失或其他任何金钱损失) 以及侵权行为、过失、严格赔偿责任或其他责任, 即使已经向 EIZO 和经销商提出了发生这些损害的可能性, 对此 EIZO 和经销商概不承担责任。本免责条款还包括因第三方向原买方提出索赔而可能发生的任何责任。本条款的本质是限定由于本有限责任保证书和 / 或销售本产品所发生的 EIZO 和经销商的潜在责任。

Recycling Information

Recycling Information

This product, when disposed of, is supposed to be collected and recycled according to your country's legislation to reduce environmental burden. When you dispose of this product, please contact a distributor or an affiliate in your country.

The contact addressees are listed on the EIZO website below.

<http://www.eizoglobal.com>

For recycling information for customers in Switzerland, please refer to the following website.

<http://www.swico.ch>

Informationen zum Thema Recycling

Dieses Produkt muss gemäß den Vorschriften Ihres Landes zur Entlastung der Umwelt recyclet werden. Wenden Sie sich bei der Entsorgung dieses Produkts an einen Verteiler oder eine Tochtergesellschaft in Ihrem Land.

Die Adressen zur Kontaktaufnahme sind auf der unten angegebenen Website von EIZO aufgeführt.

<http://www.eizoglobal.com>

Kunden in der Schweiz entnehmen Informationen zum Recycling der folgenden Website:

<http://www.swico.ch>

Informations sur le recyclage

Ce produit doit être jeté aux points de collecte prévus à cet effet et recyclé conformément à la législation de votre pays, afin de réduire l'impact sur l'environnement. Lorsque vous jetez ce produit, veuillez contacter un distributeur ou une société affiliée de votre pays.

Les adresses des distributeurs sont répertoriées sur le site Web EIZO ci-dessous.

<http://www.eizoglobal.com>

Pour les clients en Suisse, veuillez consulter le site Web suivant afin d'obtenir des informations sur le recyclage.

<http://www.swico.ch>

Información sobre reciclaje

Este producto debe desecharse y reciclarse según la legislación del país para reducir el impacto medioambiental. Cuando desee deshacerse de este producto, póngase en contacto con un distribuidor o una filial de su país.

Encontrará las direcciones de contacto en el sitio web de EIZO que se indica a continuación.

<http://www.eizoglobal.com>

Informazioni sul riciclaggio

Per lo smaltimento e il riciclaggio del presente prodotto, attenersi alle normative vigenti nel proprio paese per ridurre l'impatto ambientale. Per lo smaltimento, rivolgersi ad un distributore o un affiliato presenti nel proprio paese.

Gli indirizzi sono elencati nel sito Web EIZO riportato di seguito.

<http://www.eizoglobal.com>

Per informazioni sul riciclaggio per i clienti in Svizzera, consultare il sito Web riportato di seguito.

<http://www.swico.ch>

Återvinningsinformation

När denna produkt kasseras ska den hanteras och återvinnas enligt landets föreskrifter för att reducera miljöpåverkan. När du kasserar produkten ska du kontakta en distributör eller representant i ditt land.

Kontaktadresserna listas på EIZO-webbplatsen nedan.

<http://www.eizoglobal.com>

Πληροφορίες ανακύκλωσης

Το προϊόν αυτό, όταν απορρίπτεται, πρέπει να συλλέγεται και να ανακυκλώνεται σύμφωνα με τη νομοθεσία της χώρας σας έτσι ώστε να μην επιβαρύνει το περιβάλλον. Για να απορρίψετε το προϊόν, επικοινωνήστε με έναν αντιπρόσωπο ή μια θυγατρική εταιρεία στη χώρα σας.

Οι διευθύνσεις επικοινωνίας αναγράφονται στην τοποθεσία web της EIZO παρακάτω.
<http://www.eizoglobal.com>

Сведения по утилизации

По истечении срока службы данного продукта его следует принести на сборный пункт и утилизировать в соответствии с действующими предписаниями в вашей стране, чтобы уменьшить вредное воздействие на окружающую среду. Прежде чем выбросить данный продукт, обратитесь к дистрибьютору или в местное представительство компании в вашей стране.

Контактные адреса можно найти на веб-узле EIZO.

<http://www.eizoglobal.com>

Informatie over recycling

Wanneer u dit product wilt weggooien, moet het uit milieu-overwegingen worden verzameld en gerecycled volgens de betreffende wetgeving van uw land. Wanneer u dit product wilt weggooien, moet u contact opnemen met een distributeur of een partner in uw land.

De contactadressen worden vermeld op de volgende EIZO-website.

<http://www.eizoglobal.com>

Informação sobre reciclagem

Este produto, quando o deitar fora, deve ser recolhido e reciclado de acordo com a legislação do seu país para reduzir a poluição. Quando deitar fora este produto, contacte um distribuidor ou uma filial no seu país.

Os endereços de contacto estão listados no website do EIZO, abaixo.

<http://www.eizoglobal.com>

Oplysninger om genbrug

Dette produkt forventes ved bortskaffelse at blive indsamlet og genbrugt i overensstemmelse med lovgivningen i dit land for at reducere belastningen af miljøet. Når du bortskaffer denne produkt, skal du kontakte en distributør eller et tilknyttet selskab i dit land.

Adresserne på kontaktpersonerne er angivet på EIZO's websted nedenfor.

<http://www.eizoglobal.com>

Kierrätystä koskevia tietoja

Tuote tulee hävittää kierrättämällä maan lainsäädännön mukaisesti ympäristön kuormittumisen vähentämiseksi. Kun hävität tuotteen, ota yhteyttä jälleenmyyjään tai tytäryhtiöön maassasi.

Yhteystiedot löytyvät EIZOn Internet-sivustolta.

<http://www.eizoglobal.com>

Wykorzystanie surowców wtórnych

Ten produkt po zużyciu powinien być zbierany i przetwarzany zgodnie z krajowymi przepisami dotyczącymi ochrony środowiska. Wyrzucając ten produkt, należy skontaktować się z lokalnym dystrybutorem lub partnerem. Adresy kontaktowe można znaleźć we wskazanej poniżej witrynie internetowej firmy EIZO.

<http://www.eizoglobal.com>

Informace o recyklaci

Při likvidaci produktu musí být produkt vyzvednut a recyklován podle zákonů příslušné země, aby nedocházelo k zatěžování životního prostředí. Zbavujete-li se produktu, kontaktujte distributora nebo pobočku ve své zemi. Kontaktní adresy jsou uvedeny na následující webové stránce společnosti EIZO.
<http://www.eizoglobal.com>

Ringlussevõtu alane teave

Keskkonnakoormuse vähendamiseks tuleks kasutatud tooted kokku koguda ja võtta ringlusse vastavalt teie riigi seadustele. Kui kõrvaldate käesoleva toote, võtke palun ühendust turustaja või filiaaliga oma riigis. Kontaktisikud on toodud EIZO veebilehel järgmisel aadressil:
<http://www.eizoglobal.com>

Újrahasznosítási információ

Jelen terméket, amikor eldobjuk, az illető ország törvényei alapján kell összegyűjteni és újrahasznosítani, hogy csökkentsük a környezetet terhelését. Amikor ezt a terméket eldobja, kérjük lépjen kapcsolatba egy országon belüli forgalmazóval vagy társvállalkozással.
A kapcsolat címei az EIZO alábbi weboldalán találhatók felsorolva:
<http://www.eizoglobal.com>

Podatki o recikliranju

Ob koncu uporabe odslužen izdelek izročite na zbirno mesto za recikliranje v skladu z okoljevarstveno zakonodajo vaše države. Prosim, da se pri odstranjevanju izdelka obrnete na lokalnega distributerja ali podružnico.
Kontaktne naslovi so objavljeni na spodaj navedenih spletnih straneh EIZO:
<http://www.eizoglobal.com>

Informácie o recyklácii

Pri likvidácii musí byť tento výrobok recyklovaný v súlade s legislatívou vašej krajiny, aby sa znížilo zaťaženie životného prostredia. Keď sa chcete zbaviť tohto výrobku, kontaktujte prosím distribútora alebo pobočku vo vašej krajine.
Zoznam kontaktných adries je uvedený na nasledovnej webovej stránke firmy EIZO:
<http://www.eizoglobal.com>

Pārstrādes informācija

Utilizējot šo produktu, tā savākšana un pārstrāde veicama atbilstoši jūsu valsts likumdošanas prasībām attiecībā uz slodzes uz vidi samazināšanu. Lai veiktu šī produkta utilizāciju, sazinieties ar izplatītāju vai pārstāvniecību jūsu valstī.
Kontaktadrese ir norādītas zemāk minētajā EIZO tīmekļa vietnē.
<http://www.eizoglobal.com>

Informacja apie gražinamąjį perdirbimą

Šalinant (išmetant) šiuos gaminius juos reikia surinkti ir perdirbti gražinamuoju būdu pagal jūsų šalies teisės aktus, siekiant sumažinti aplinkos teršimą. Kai reikia išmesti šį gaminį, kreipkitės į jūsų šalyje veikiančią gaminių pardavimo atstovybę arba jos filialą.
Kontaktiniai adresatai nurodyti EIZO interneto svetainėje.
<http://www.eizoglobal.com>

Информация относно рециклиране

При изхвърлянето на този продукт се предлага събирането и рециклирането му съобразно законите на вашата страна за да се намали замърсяването на околната среда. Когато искате да се освободите от този продукт, моля свържете се с търговския му представител или със съответните органи отговарящи за това във вашата страна.

Данните за връзка с нас са описани на следния Интернет сайт на EIZO:
<http://www.eizoglobal.com>

Informație referitoare la reciclare

Acest produs, când debarasat, trebuie colectat și reciclat conform legislației țării respective ca să reducem sarcina mediului. Când se debarasează de acest produs, vă rugăm să contactați un distribuitor sau un afiliat al țării respective.

Adresele de contact le găsiți pe pagina de web al EIZO:
<http://www.eizoglobal.com>

معلومات عن إعادة التدوير

عند التخلص من هذا المنتج، من الضروري تجميعه وإعادة تدويره وفقاً للقوانين المتبعة في بلدك لتقليل العبء المسلط على البيئة. عندما تتخلص من هذا المنتج، يرجى الاتصال بموزع أو طرف متنسب إليه في بلدك. عناوين الاتصال مدرجة في موقع ايزو EIZO ادناه على شبكة الانترنت.

<http://www.eizoglobal.com>

Geri Dönüşüm Bilgisi

Bu ürünün, atılacağı zaman, ülkenizin çevre kirliliğinin azaltılması konusundaki mevzuatına göre toplanması ve yeniden değerlendirilmesi gerekmektedir. Ürünü atacağınız zaman lütfen ülkenizdeki bir distribütör veya ilgili kuruluşla temasa geçiniz.

İrtibat adresleri aşağıdaki EIZO web sitesinde verilmiştir.
<http://www.eizoglobal.com>



EIZO Corporation

153 Shimokashiwano, Hakusan, Ishikawa 924-8566 Japan

艺卓显像技术(苏州)有限公司

中国苏州市苏州工业园区展业路 8 号中新科技工业坊 5B

EC REP

EIZO GmbH

Siemensallee 84, 76187 Karlsruhe, Germany

<http://www.eizoglobal.com>

Copyright © 2011-2018 EIZO Corporation. All rights reserved.



03V23829G1
UM-RX340

7th Edition-May, 2018 Printed in Japan.