

User's Manual

RadiForce® GS521-BL GS521-CL GS521-CLG

Monochrome LCD Monitor

Important

Please read PRECAUTIONS, this User's Manual, and the Setup Manual (separate volume) carefully to familiarize yourself with safe and effective usage.

-
- Please refer to the Setup Manual for basic information ranging from connection of the monitor to a PC to using the monitor.
 - The latest User's Manual is available for download from our web site:
<http://www.eizo.com>
-



This product has been adjusted specifically for use in the region to which it was originally shipped. If operated outside this region, the product may not perform as stated in the specifications.

- It shall be assured that the final system is in compliance to IEC60601-1-1 requirement.
- Power supplied equipment can emit electromagnetic waves, that could influence, limit or result in malfunction of the monitor. Install the equipment in a controlled environment, where such effects are avoided.
- This is a monitor intended for use in a medical imaging system.

No part of this manual may be reproduced, stored in a retrieval system, or transmitted, in any form or by any means, electronic, mechanical, or otherwise, without the prior written permission of EIZO NANA O CORPORATION.

EIZO NANA O CORPORATION is under no obligation to hold any submitted material or information confidential unless prior arrangements are made pursuant to EIZO NANA O CORPORATION's receipt of said information. Although every effort has been made to ensure that this manual provides up-to-date information, please note that EIZO monitor specifications are subject to change without notice.

Apple, Mac, Macintosh, iMac, eMac, Mac OS, MacBook, PowerBook, ColorSync, QuickTime, and iBook are registered trademarks of Apple Inc.

Windows, Windows Vista, Windows Media, SQL Server, and Xbox 360 are registered trademarks of Microsoft Corporation in the United States and other countries.

A round gothic bold bit map font designed by Ricoh is used for the characters displayed on this product.

VESA is a registered trademark or a trademark of the Video Electronics Standards Association in the United States and other countries.

EIZO, the EIZO Logo, ColorEdge, DuraVision, FlexScan, FORIS, RadiForce, RadiCS, RadiNET, Raptor, and ScreenManager are registered trademarks of EIZO NANA O CORPORATION in Japan and other countries.

All other company and product names are trademarks or registered trademarks of their respective owners.

Notice for this monitor

This product is suited to displaying medical images of such modalities as MRI, CT and digital mammography.

This product has been adjusted specifically for use in the region to which it was originally shipped. If the product is used outside the region, it may not operate as specified in the specifications.

This product may not be covered by warranty for uses other than those described in this manual.

The specifications noted in this manual are only applicable when the following are used:

- Power cords provided with the product
 - Signal cables specified by us
-

Only use optional products manufactured or specified by us with this product.

As it takes about 30 minutes for the performance of electrical parts to stabilize, adjust the monitor 30 minutes or more after the monitor power has been turned on.

Monitors should be set to a lower brightness to reduce changes in luminosity caused by long-term use and maintain a stable display.

When the screen image is changed after displaying the same image for extended periods of time, an afterimage may appear. Use the screen saver or power save function to avoid displaying the same image for extended periods of time.

Periodic cleaning is recommended to keep the monitor looking new and to prolong its operation lifetime. (Refer to “[Cleaning](#)” on the next page.)

The screen may have defective pixels or a small number of light dots on the screen. This is due to the characteristics of the panel itself, and is not a malfunction of the product.

The backlight of the LCD panel has a fixed lifetime. When the screen becomes dark or begins to flicker, please contact your dealer.

Do not press on the panel or edge of the frame strongly, as this may result in display malfunctions, such as interference patterns, etc. If pressure is continually applied to the panel, it may deteriorate or damage your panel. (If the pressure marks remain on the panel, leave the monitor with a black or white screen. The symptom may disappear.)

Do not scratch or press on the panel with any sharp objects, as this may result in damage to the panel. Do not attempt to brush with tissues as this may scratch the panel.

When the monitor is cold and brought into a room or the room temperature goes up quickly, dew condensation may occur on the interior and exterior surfaces of the monitor. In that case, do not turn the monitor on. Instead wait until the dew condensation disappears, otherwise it may cause some damage to the monitor.

Cleaning

Attention

- Chemicals such as alcohol and antiseptic solution may cause gloss variation, tarnishing, and fading of the cabinet or panel, and also quality deterioration of the image.
- Never use any thinner, benzene, wax, and abrasive cleaner, which may damage the cabinet or panel.

Note

- The optional ScreenCleaner is recommended for cleaning the cabinet and panel surface. (“ScreenCleaner” is supplied with GS521-CLG.)

If necessary, the stains on the cabinet and panel surface can be removed by moistening part of a soft cloth with water.

To use the monitor comfortably

- An excessively dark or bright screen may affect your eyes. Adjust the brightness of the monitor according to the environmental conditions.
- Staring at the monitor for a long time tires your eyes. Take a 10-minute rest every hour.

CONTENTS

Cover	1	Chapter 4 Power Saving Function	17
Notice for this monitor	3	4-1. Setting the Power Saving [Power Save]	17
CONTENTS	5	4-2. Setting Power Indicator [Power Indicator] ..	17
Chapter 1 Introduction	6	Chapter 5 Troubleshooting	18
1-1. Features.....	6	Chapter 6 Reference	20
1-2. Switches and Indicators.....	6	6-1. Attaching an Arm	20
1-3. Utility Disk.....	7	6-2. Connecting Two PCs to the Monitor	21
● Disk contents and software overview	7	● To switch the input signal.....	21
● To RadiCS LE or ScreenManager Pro for Medical	7	● To set input signal selection [Input Selection]..	22
1-4. Basic Operation and Functions.....	8	6-3. Making Use of USB (Universal Serial Bus). 23	
Basic operation of Adjustment menu.....	8	● Required System Environment	23
Functions	9	● Connection Procedure (Setup of USB Function).	23
Chapter 2 Adjusting Screen	10	6-4. Displaying Monitor Information	24
2-1. Setting Screen Resolution.....	10	● Displaying signal information [Signal Info].....	24
Compatible Resolutions/Frequencies.....	10	● Displaying monitor information [Monitor Info] ..	24
Setting Resolution	10	6-5. Specifications.....	25
● Windows 7.....	10	6-6. Glossary	29
● Windows Vista	10	FCC Declaration of Conformity	30
● Windows XP.....	10	EMC Information	31
● Mac OS X.....	10	LIMITED WARRANTY	34
2-2. Selecting Display Mode.....	11		
2-3. Adjusting Brightness [Brightness].....	11		
Chapter 3 Setting Monitor	12		
3-1. Setting Orientation [Orientation]	12		
3-2. Setting the Input Signals [Signal Selection]13			
● DVI Connection (Dual Link/Single Link)	13		
● DVI Connection (SDG/Packed Pixel).....	13		
● DisplayPort Connection	14		
3-3. Enabling/Disabling Mode Selection [Mode Preset]	14		
3-4. Locking Switches [Key Lock]	14		
3-5. Setting the EIZO Logo Display [Logo]	15		
3-6. Setting Language [Language]	15		
3-7. Setting the Display Position of the Adjustment Menu [Menu Position].....	15		
3-8. Restoring the Default Setting	16		
● To reset brightness adjustment values [Mode Reset].....	16		
● To reset all adjustments to the factory default settings [All Reset]	16		

Chapter 1 Introduction

Thank you very much for choosing an EIZO Monochrome Monitor.

1-1. Features

- Resolution: 5M pixels (Portrait : 2048 × 2560 dots (H × V))
- 15 Mega Sub-Pixels Display
The GS521 comes with a Sub-Pixel Drive (SPD) function capable of displaying 2048 × 7680 super high resolution by controlling each sub-pixel separately. With a 15 mega sub-pixels (MsP), sufficient information volume of the original medical image will be displayed, making the monitor suitable for rendering the outline of a detailed digital mammography image more sharply.
*15MsP viewer software needed for 15MsP display.
*10-bit simultaneous display supported when displaying 15MsP.
- Applicable to DisplayPort (applicable to 8 bit or 10 bit, not applicable to audio signals)
- 2 signal input terminals (DVI-D x 1, DisplayPort x 1)
- CAL Switch function for selecting an optimal calibration mode
“2-2. Selecting Display Mode” (page 11)
- DICOM mode (CAL Switch function) (page 29)
- The quality control software “RadiCS LE” (for Windows) used to calibrate the monitor is included
“1-3. Utility Disk” (page 7)
- The software “ScreenManager Pro for Medical” (for Windows) to adjust the screen using the mouse and keyboard is included
“1-3. Utility Disk” (page 7)
- Frame Synchronous mode supported (24.5 - 25.5Hz, 49 - 51Hz)
- HDCP (High-bandwidth Digital Content Protection)

1-2. Switches and Indicators

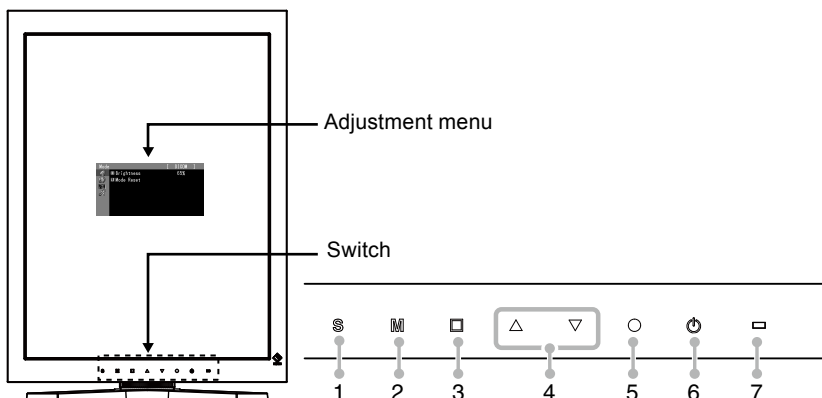

1. **S** switch
2. **M** switch
3. **□** switch
4. **△▽** switch
5. **○** switch
6. **⏻** switch
7. Power Indicator

Indicator status	Operation status
Green	The screen is displayed
Orange	Power saving
Off	Main Power Switch / Power Switch off

1-3. Utility Disk

An “EIZO LCD Utility Disk” (CD-ROM) is supplied with the monitor. The following table shows the disk contents and the overview of the software programs.

- **Disk contents and software overview**

The disk includes application software programs for adjustment, and User’s Manual. Refer to “Readme.txt” file on the disk for software startup procedures or file access procedures.

Item	Overview
A “Readme.txt” file	
RadiCS LE (for Windows)	RadiCS LE is quality control software used to calibrate the monitor and manage the calibration history. (A PC must be connected to the monitor with the supplied USB cable.) Refer to the description later.
RadiCS Monitor File (for Windows)	This is the monitor setting file required when using RadiCS. For information about installing this file, see the RadiCS User’s Manual.
ScreenManager Pro for Medical (for Windows)	A utility software program to control monitor adjustments from a PC using its mouse and keyboard. (A PC must be connected to the monitor with the supplied USB cable.) Refer to the description later.
User’s Manual (PDF file)	

- **To RadiCS LE or ScreenManager Pro for Medical**

Refer to the corresponding User’s Manual on the CD-ROM disk in order to install and use the software. When using this software, you will need to connect a PC to the monitor with the supplied USB cable. For more information refer to the “6-3. Making Use of USB (Universal Serial Bus)” ([page 23](#)).

1- 4. Basic Operation and Functions

Basic operation of Adjustment menu

1 Displaying Adjustment Menu

Press **O**.

The adjustment menu appears.

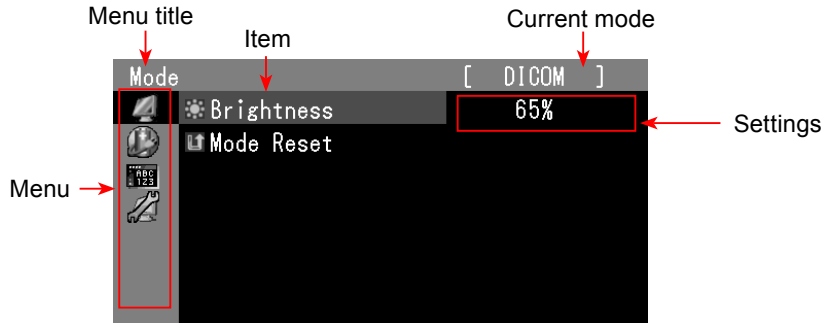

2 Adjusting/Setting

1. Choose a menu to adjust/set with **Δ**/**∇**, and press **O**.

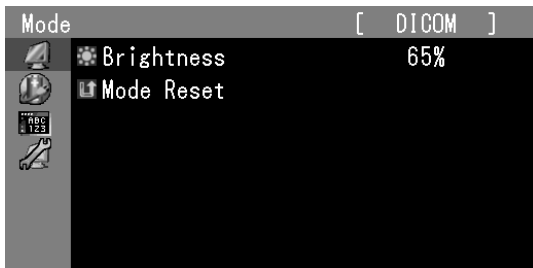

2. Choose an item to adjust/set with **Δ**/**∇**, and press **O**.



3. Adjust/set the selected item with **Δ**/**∇**, and press **O**.

















3 Exiting

Press **□** a few times.

The adjustment menu finishes.

Functions

The following table shows all the Adjustment menu's adjustment and setting menus.

Main Menu	Item	Adjusting/Setting
Mode 	 Brightness	"2-3. Adjusting Brightness" (page 11)
	 Mode Reset	"3-8. Restoring the Default Setting" (page 16)
PowerManager 	 Power Save	"4-1. Setting the Power Saving" (page 17)
	 Power Indicator	"4-2. Setting Power Indicator" (page 17)
Menu Settings 	 Language	"3-6. Setting Language" (page 15)
	 Menu Position	"3-7. Setting the Display Position of the Adjustment Menu" (page 15)
Tools 	 Input Selection	"6-2. Connecting Two PCs to the Monitor" (page 21)
	 Mode Preset	"3-3. Enabling/Disabling Mode Selection" (page 14)
	 Signal Info	"6-4. Displaying Monitor Information" (page 24)
	 Monitor Info	
	 All Reset	"3-8. Restoring the Default Setting" (page 16)

Chapter 2 Adjusting Screen

2-1. Setting Screen Resolution

Compatible Resolutions/Frequencies

For details on compatible resolutions, refer to “Compatible Resolutions/Frequencies” in the Setup Manual.

Setting Resolution

When you connect the monitor to the PC and find that the resolution is improper, or when you want to change the resolution, follow the procedure below.

● Windows 7

1. Right-click the mouse anywhere on the desktop except for icons.
2. From the displayed menu, click “Screen resolution”.
3. On the “Screen Resolution” dialog, select the monitor .
4. Click “Resolution” to select the desired resolution.
5. Click the [OK] button.
6. When a confirmation dialog is displayed, click [Keep changes].

● Windows Vista

1. Right-click the mouse anywhere on the desktop except for icons.
2. From the displayed menu, click “Personalize”.
3. On the “Personalization” window, click “Display Settings”.
4. On the “Display Settings” dialog, select the “Monitor” tab and select desired resolution in the “Resolution” field.
5. Click the [OK] button.
6. When a confirmation dialog is displayed, click [Yes].

● Windows XP

1. Right-click the mouse anywhere on the desktop except for icons.
2. From the displayed menu, click “Properties”.
3. When the “Display Properties” dialog is displayed, click the “Settings” tab and select desired resolution for “Screen resolution” under “Display”.
4. Click the [OK] button to close the dialog.

● Mac OS X

1. Select “System Preferences” from the Apple menu.
2. When the “System Preferences” dialog is displayed, click “Displays” for “Hardware”.
3. On the displayed dialog, select the “Display” tab and select desired resolution in the “Resolutions” field.
4. Your selection will be reflected immediately. When you are satisfied with the selected resolution, close the window.

2-2. Selecting Display Mode

CAL Switch allows you to select easily the adequate mode suitable for the monitor's application.

CAL Switch mode

Mode	Purpose
1-DICOM	Available to display in DICOM mode.
2-Native	Available for displaying images using the native characteristics of the monitor panel.
3-CAL	Displays the screen adjusted by calibration software.

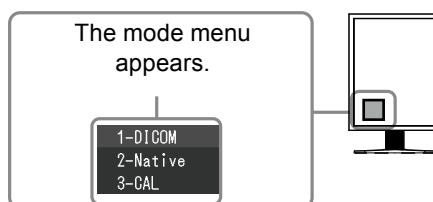

Procedure

1. Press **M** .
Mode menu appears at the lower left of the screen.
2. The mode among the list is highlighted in turn each time **M** is pressed.
You can switch the current mode with Δ or ∇ while the mode menu is being displayed.

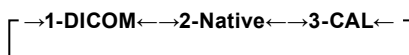

NOTE

- The Adjustment menu and the Mode menu cannot be displayed at the same time.
- You can disable a specific mode to be selected. For more information, refer to “3-3 Enabling/Disabling Mode Selection” ([page 14](#)).

2-3. Adjusting Brightness [Brightness]

The screen brightness is adjusted by changing the brightness of the backlight (Light source from the LCD back panel).

Adjustable range: 0 to 100%

Procedure

1. Choose <Mode> from the Adjustment menu, and press \circ .
2. Choose <Brightness> from the <Mode> menu, and press \circ .
3. Adjust the brightness with Δ or ∇ .
4. Press \circ to exit the adjustment.

NOTE

- You can also adjust the brightness using Δ and ∇ . (When the Adjustment menu does not appear.)

Chapter 3 Setting Monitor

3-1. Setting Orientation [Orientation]



This function changes the display orientation of the image based on the operating environment..

Attention

- Refer to the manual of the graphics board.
- The operating environments described below can be set regardless of whether or not the computer is running.

Procedure

1. Press ⏻ to turn off the monitor.
2. Press **M** holding ⏻ down for at least 2 seconds to turn on the monitor.
The Optional Settings menu appears.
3. Choose <Orientation> from the <Optional Settings> menu, and press ○ .
4. Select “Landscape”, “Portrait (SW)”, or “Portrait (HW)” with Δ or ∇ , and press ○ .

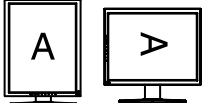
Monitor Orientation	Display Example
Landscape Select this option when using the Landscape orientation.	
Portrait (SW) Select this option when using the Portrait orientation. Graphics board utility software is used to rotate the display image 90 degrees.	
Portrait (HW) Select this option when using the Portrait orientation. The monitor function is used to rotate the display image 90 degrees.	

5. Select “Finish” with Δ or ∇ .
6. Press ○ to exit.
The Optional Settings menu is closed.

3-2. Setting the Input Signals [Signal Selection]

Signals can be selected based on your operating environment..

Attention

- A supported graphics board is required to display.
- Refer to the manual of the graphics board.

● DVI Connection (Dual Link/Single Link)

Procedure

1. Press ⏻ to turn off the monitor.
2. Press **M** holding ⏻ down for at least 2 seconds to turn on the monitor.
The Optional Settings menu appears.
3. Choose <Signal Selection> from the <Optional Settings> menu, and press ○ .
4. Select “DVI” with Δ or ∇ , and press ○ .
5. Select “Signal Format” with Δ or ∇ , and press ○ .
6. Select “Dual Link” or “Single Link” with Δ or ∇ , and press ○ .
7. Select “Sub Pixel Drive” with Δ or ∇ , and press ○ .
8. Select “On” or “Off” with Δ or ∇ , and press ○ .
9. Press \square twice, and use Δ or ∇ to select "Finish" from the <Optional Settings> menu.
10. Press ○ to exit.
The Optional Settings menu is closed.

● DVI Connection (SDG/Packed Pixel)

Procedure

1. Press ⏻ to turn off the monitor.
2. Press **M** holding ⏻ down for at least 2 seconds to turn on the monitor.
The Optional Settings menu appears.
3. Choose <Signal Selection> from the <Optional Settings> menu, and press ○ .
4. Select “DVI” with Δ or ∇ , and press ○ .
5. Select “Signal Format” with Δ or ∇ , and press ○ .
6. Select “SDG” or “Packed Pixel” with Δ or ∇ , and press ○ .
7. Select “Bit” with Δ or ∇ , and press ○ .
8. Select “8bit” or “10bit”(SDG)/“8/10bit” or “12bit”(Packed Pixel) with Δ or ∇ , and press ○ .
9. Select “Sub Pixel Drive”(SDG : 8bit) with Δ or ∇ , and press ○ .
10. Select “On” or “Off”(SDG : 8bit) with Δ or ∇ , and press ○ .
11. Press \square twice, and use Δ or ∇ to select "Finish" from the <Optional Settings> menu.
12. Press ○ to exit.
The Optional Settings menu is closed.

● DisplayPort Connection

Procedure

1. Press ⏻ to turn off the monitor.
2. Press **M** holding ⏻ down for at least 2 seconds to turn on the monitor.
The Optional Settings menu appears.
3. Choose <Signal Selection> from the <Optional Settings> menu, and press ○ .
4. Select “DisplayPort” with Δ or ∇ , and press ○ .
5. Select “Sub Pixel Drive”, and press ○ .
6. Select “On” or “Off” with Δ or ∇ , and press ○ .
7. Press \square twice, and use Δ or ∇ to select "Finish" from the <Optional Settings> menu.
8. Press ○ to exit.
The Optional Settings menu is closed.

3-3. Enabling/Disabling Mode Selection [Mode Preset]

Allows you to select the specified modes only.

Use this function when all the display modes are not available or when keeping the display mode unchanged.

Procedure

1. Choose <Tools> from the Adjustment menu, and press ○ .
2. Choose <Mode Preset> from the <Tools> menu, and press ○ .
3. Select the mode to change its settings with Δ or ∇ , and press ○ .
4. Select “On” or “Off” with Δ or ∇ .
5. Press ○ to exit the adjustment.

Attention

- You cannot set all the modes disable. Set at least one mode to “On”.
-

3-4. Locking Switches [Key Lock]

This function allows you to lock to prevent changing the adjusted/set status.

Procedure

1. Press ⏻ to turn off the monitor.
2. Press **M** holding ⏻ down for at least 2 seconds to turn on the monitor.
The Optional Settings menu appears.
3. Choose <Key Lock> from the <Optional Settings> menu, and press ○ .
4. Select “Off”, “Menu”, or “All” with Δ or ∇ , and press ○ .

Settings	Switches that can be locked
Off (Initial settings)	None (All switches are enabled)
Menu	○ switch Δ ∇ switch
All	All switches excluding ⏻

5. Select “Finish” with Δ or ∇ .
6. Press ○ to exit.
The Optional Settings menu is closed.

3-5. Setting the EIZO Logo Display [Logo]

This function allows you to display, or not, the EIZO logo.

Procedure

1. Press \odot to turn off the monitor.
2. Press **M** holding \odot down at least 2 seconds to turn on the monitor.

The Optional Settings menu appears.

3. Choose <Logo> from the <Optional Settings> menu, and press \odot .
4. Select “On” or “Off” with Δ or ∇ , and press \odot .
5. Select “Finish” with Δ or ∇ .
6. Press \odot to exit the Optional Settings.

The Optional Settings menu is closed.

3-6. Setting Language [Language]

This function allows you to select a language for the adjustment menu or displaying message.

Selectable languages

English/German/French/Spanish/Italian/Swedish/Japanese /Simplified Chinese/Traditional Chinese

Procedure

1. Choose <Menu Settings> menu from the Adjustment menu, and press \odot .
2. Choose <Language> from the <Menu Settings> menu, and press \odot .
3. Choose a language with Δ or ∇ .
4. Press \odot to exit the adjustment.

3-7. Setting the Display Position of the Adjustment Menu [Menu Position]

Adjust the menu position using the following procedure.

Procedure

1. Choose <Menu Settings> from the Adjustment menu, and press \odot .
2. Choose <Menu Position> from the <Menu Settings> menu, and press \odot .
3. Select a menu position with Δ or ∇ .
4. Press \odot to exit the adjustment.

3-8. Restoring the Default Setting

There are two types of Reset. One is used to reset the brightness adjustment only to the default settings, and the other is used to reset all the settings, except for the optional settings, to the default settings.

Attention

- After resetting, you cannot undo the operation.
-

NOTE

- For main default settings, refer to “Main default settings (factory settings)” on [page 26](#).
-

● To reset brightness adjustment values [Mode Reset]

Only the adjustment values in the current mode will revert to the default settings (factory settings).

Procedure

1. Choose <Mode> from the Adjustment menu, and press \circ .
2. Choose <Mode Reset> from the <Mode> menu and press \circ .
3. Select “Execute” with \triangle or ∇ .
4. Press \circ to exit the adjustment.

The adjustment values revert to the default settings.

● To reset all adjustments to the factory default settings [All Reset]

Reset all adjustments except for the optional settings to the factory default settings.

NOTE

- <Logo>, <Key Lock>, <Signal Selection>, and <Orientation> in the <Optional Sttings> menu are not returned to the default settings.
-

Procedure

1. Choose <Tools> from the Adjustment menu, and press \circ .
2. Choose <All Reset> from the <Tools> menu, and press \circ .
3. Select “Execute” with \triangle or ∇ .
4. Press \circ to exit the adjustment.

All settings except for the optional settings revert to the default settings.

Chapter 4 Power Saving Function

4-1. Setting the Power Saving [Power Save]

This function allows you to set the monitor into the power saving mode according to the PC status. When the monitor enters the power saving mode, no image is displayed on the screen.

Attention

- Turning off the main power switch or unplugging the power cord completely shuts off power supply to the monitor.
- Devices connected to the USB port (upstream and downstream) work when the monitor is in power saving mode or when the power switch of the monitor is Off. Therefore, power consumption of the monitor varies with connected devices even in the power saving mode.

Power Save is compliant with the following standards for the respective signal inputs.

signal inputs		Standard
Digital signal	DVI	DVI DMPM
	DisplayPort	DisplayPort Standard V1.1a

Procedure

1. Choose <PowerManager> from the Adjustment menu, and press \odot .
2. Choose <Power Save> from the <PowerManager> menu, and press \odot .
3. Select “On” or “Off” with Δ or ∇ .
4. Press \odot to exit the adjustment.

Power Saving System

The monitor enters the power saving mode in conjunction with the PC settings.

PC		Monitor Power	Indicator
Operating		Operating	Green
Power saving	STAND-BY SUSPENDED OFF	Power saving	Orange

4-2. Setting Power Indicator [Power Indicator]

The brightness of the power indicator (blue) when the screen is displayed can be adjusted (default setting is set to light up when power is turned on, and brightness is set to 4).

Procedure

1. Choose <PowerManager> from the Adjustment menu, and press \odot .
2. Choose <Power Indicator> from the <PowerManager> menu, and press \odot .
3. Select the indicator brightness “Off” or in the range from 1 to 7 with Δ or ∇ as desired.
4. Press \odot to exit the adjustment.

Chapter 5 Troubleshooting

If a problem still remains after applying the suggested remedies, contact your local dealer.

- No-picture problems → See No.1 - No.2.
- Imaging problems → See No.3 - No.7.
- Other problems → See No.8 - No.10.

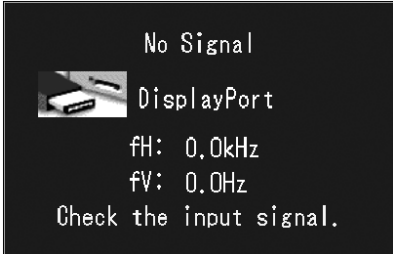
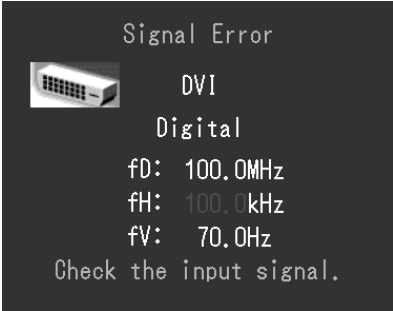
Problems	Possible cause and remedy
<p>1. No picture</p> <ul style="list-style-type: none"> • Power indicator does not light. 	<ul style="list-style-type: none"> • Check whether the power cord is connected correctly. • Turn off the main power, and then turn it on again a few minutes later. • Turn the main power switch on. • Press .
<ul style="list-style-type: none"> • Power indicator lights green. • Power indicator lights orange. 	<ul style="list-style-type: none"> • Switch the input signal with S. • Operate the mouse or keyboard. • Check whether the PC is turned on.
<p>2. The message below appears.</p> <ul style="list-style-type: none"> • This message appears when no signal is input. Example: 	<p>This message appears when the signal is not input correctly even when the monitor functions properly.</p> <ul style="list-style-type: none"> • The message shown left may appear, because some PCs do not output the signal soon after power-on. • Check whether the PC is turned on. • Check whether the signal cable is connected properly. • Switch the input signal with S.
<ul style="list-style-type: none"> • The message shows that the input signal is out of the specified frequency range. Example: 	<ul style="list-style-type: none"> • Check whether the signal setting of your PC matches the resolution and the vertical frequency settings for the monitor. (refer to the Setup Manual "Setting Screen Resolution") • Reboot the PC. • Select an appropriate display mode using the graphics board's utility. Refer to the manual of the graphics board for details. fD : Dot Clock fH : Horizontal Frequency fV : Vertical Frequency
<p>3. The screen is too bright or too dark.</p>	<ul style="list-style-type: none"> • Adjust using <Brightness>. (The LCD monitor backlight has a fixed life span. When the screen becomes dark or begins to flicker, contact your local dealer.)
<p>4. Characters are blurred</p>	<ul style="list-style-type: none"> • Check whether the signal setting of your PC matches the resolution and the vertical frequency settings for the monitor. (refer to the Setup Manual "Setting Screen Resolution")
<p>5. Afterimages appear</p>	<ul style="list-style-type: none"> • Afterimages are particular to LCD monitors. Avoid displaying the same image for a long time. • Use the screen saver or power save function to avoid displaying the same image for extended periods of time.

Problems	Possible cause and remedy
6. Interference patterns or pressure marks remain on the screen.	<ul style="list-style-type: none"> • Leave the monitor with a white or black screen. The symptom may disappear.
7. Noise appears on the screen.	<ul style="list-style-type: none"> • When entering the signals of HDCP system, the normal images may not be displayed immediately.
8. The adjustment menu does not appear.	<ul style="list-style-type: none"> • Check whether the operation lock function works. (page 14)
9. Mode menu does not appear.	<ul style="list-style-type: none"> • Check whether the operation lock function works. (page 14)
10. The monitor connected with the USB cable is not detected. / USB devices connected to the monitor does not work.	<ul style="list-style-type: none"> • Check whether the USB cable is connected correctly. (page 23) • Change the USB port to another one. If the PC or peripheral devices works correctly by changing the USB port, contact your local dealer. (Refer to the manual of the PC for details.) • Reboot the PC. • If the peripheral devices work correctly when the PC and peripheral devices are connected directly, please contact your local dealer. • Check whether the PC and OS are USB compliant. (For USB compliance of the respective devices, consult their manufacturers.) • Check the PC's BIOS setting for USB when using Windows. (Refer to the manual of the PC for details.)

Chapter 6 Reference

6-1. Attaching an Arm

The stand can be removed and replaced with an arm (or another stand) to be attached to the monitor. Use an arm or stand of EIZO option.

Attention

- When attaching an arm or stand, follow the instructions of their user's manual.
- When using another manufacturer's arm or stand, confirm the following in advance and select one conforming to the VESA standard.
 - Clearance between the screw holes: 100 mm × 100 mm
 - Thickness of plate: 2.6 mm
 - Strong enough to support weight of the monitor unit (except the stand) and attachments such as cables.
- When using an arm or stand, attach it to meet the following tilt angles of the monitor.
 - Up 45 degrees, down 45 degrees (horizontal display, and vertical display rotated 90 degrees counter-clockwise)
- Connect the cables after attaching an arm or a stand
- Do not adjust the height of the stand removed from the monitor. When adjusted without attached monitor, it causes the personnel injury or the damaged to the stand.
- Since the monitor and arm or stand are so heavy, dropping them may result in injury or equipment damage.

[Attachment Procedure]

1 Lay the LCD monitor on a soft cloth spread over on a stable surface with the panel surface facing down.

2 Remove the stand.

Prepare a screwdriver. Unscrew the four screws securing the unit and the stand with the screwdriver.

3 Attach the monitor to the arm or stand.

Secure the monitor to the arm or stand using the screws specified in the user's manual of the arm or stand.

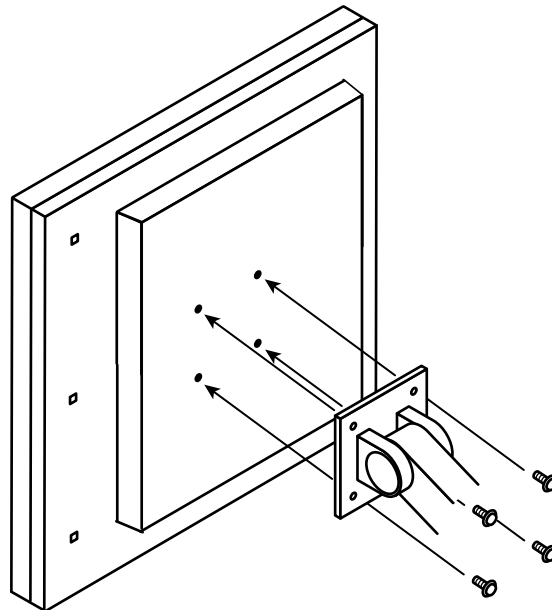

6-2. Connecting Two PCs to the Monitor

Two PCs can be connected to the monitor through the DVI-D and the DisplayPort connector on the back of the monitor.

Connection examples

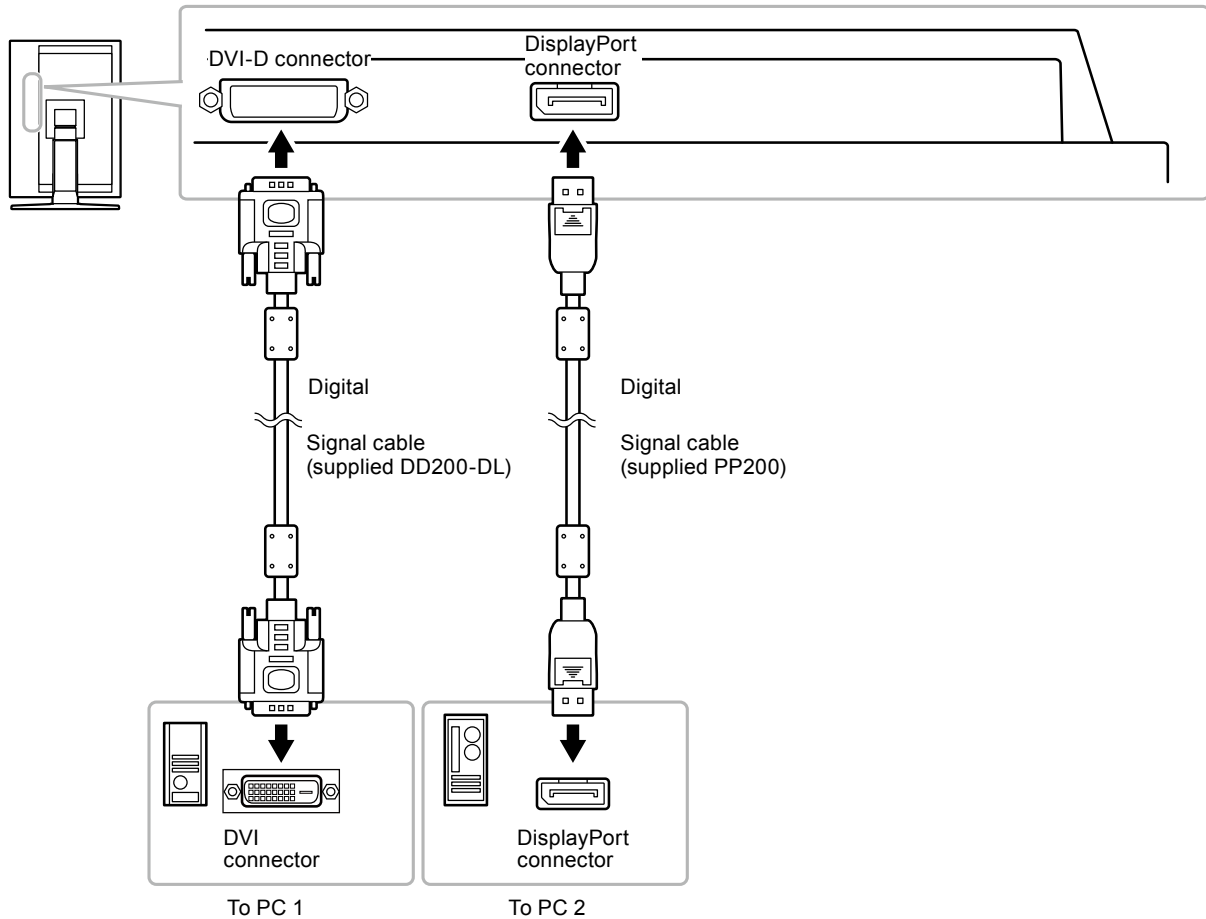

● To switch the input signal

The input signal switches each time **S** is pressed.

When the signal is switched, the active input port name appears at the top right corner of the screen.

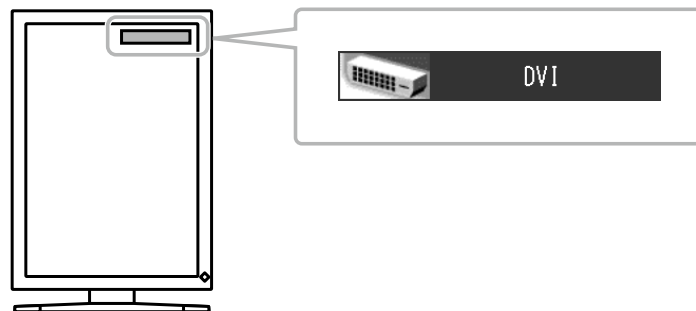

● To set input signal selection [Input Selection]

Setting	Function
Auto	The monitor recognizes the connector through which PC signals are input. When a PC is turned off or enters the powersaving mode, the monitor automatically displays another signal.
Manual	The monitor detects only the PC's signals currently displaying automatically. Select an active input signal with S .

Procedure

1. Choose <Tools> from the Adjustment menu, and press **O** .
2. Choose <Input Selection> from the <Tools> menu, and press **O** .
The <Input Selection> menu appears.
3. Select “Auto” or “Manual” with **Δ** or **∇** .
4. Press **O** to exit the adjustment.

Attention

- When “Auto” is selected for <Input Signal>, the monitor’s power-saving function works only when all PCs are in the power-saving mode.
-

6-3. Making Use of USB (Universal Serial Bus)

This monitor has a hub compatible with USB. Connected to a PC compatible with USB or another USB hub, this monitor functions as a USB hub allowing connection to peripheral USB devices.

● Required System Environment

1. A PC equipped with a USB port or another USB hub connected to a USB compatible PC
2. Windows 2000/XP/Vista/7 or Mac OS 9.2.2 and Mac OS X 10.2 or later
3. EIZO USB cable (MD-C93)

Attention

- This monitor may not work depending on PC, OS or peripheral devices to be used. For USB compatibility of peripheral devices, contact their manufactures.
- Devices connected to the USB port (upstream and downstream) work when the monitor is in power saving mode or when the power switch of the monitor is Off. Therefore, power consumption of the monitor varies with connected devices even in the power saving mode.
- When the main power switch is Off, device connected to the USB port will not operate.

● Connection Procedure (Setup of USB Function)

1. Connect the monitor first to a PC using the signal cable, and run the PC.
2. Connect the supplied USB cable between the downstream USB port of a USB compatible PC (or another USB hub) and the monitor's upstream USB port.
The USB hub function is set up automatically upon connection of the USB cable.
3. Connect the peripheral USB device to the USB port (downstream) of the monitor.

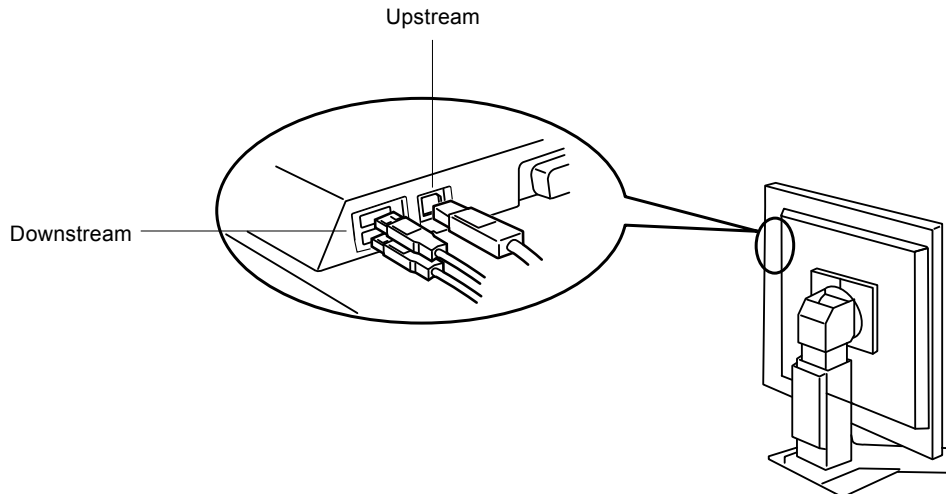

6-4. Displaying Monitor Information

● Displaying signal information [Signal Info]

This function displays the information about the current input signals displayed.

1. Choose <Tools> from the Adjustment menu, and press \odot .
 2. Choose <Signal Info> from the <Tools> menu, and press \odot .
- The Signal Info screen appears.

(Example)

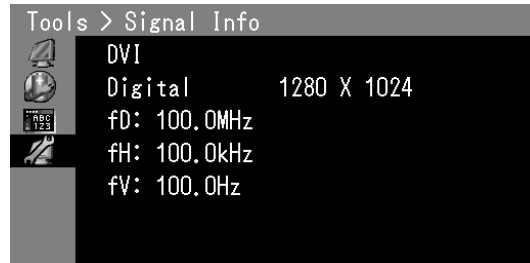

● Displaying monitor information [Monitor Info]

This function displays the information about the monitor.

1. Choose <Tools> from the Adjustment menu, and press \odot .
 2. Choose <Monitor Info> from the <Tools> menu, and press \odot .
- The Monitor Info screen appears.

(Example)

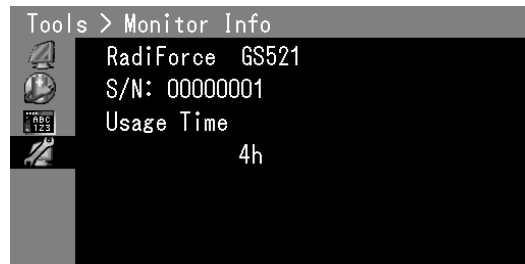

Attention

- The usage time is not always "0" due to factory inspection when you purchase the monitor.
-

6-5. Specifications

LCD Panel	Size	21.3-inch (540 mm) TFT Monochrome LDC panel
	Surface treatment (GS521-CL/BL)	Anti-Glare
	Surface treatment (GS521-CLG)	Glare
	Surface hardness	3H
	Viewing angle	Viewing angle : Horizontal 170°, Vertical 170° (CR:10 or more)
	Dot Pitch	0.165 mm
	Response Time	Approx. 50 ms
Horizontal Scan Frequency		31-135 kHz
Vertical Scan Frequency		19 ~ 61Hz (VGA TEXT : 69 ~ 71Hz / QSXGA : 19 ~ 51Hz)
Resolution		5M pixels (Portrait: 2048 × 2560 dots (H × V)) 15M Sub-Pixels (Portrait: 2048 × 7680 dots (H × V) ([Sub Pixel Drive] : "On"))
Max. Dot Clock		290 MHz
Gray Scale		4096 steps of 13771 steps (12 bit signal input, [Sub Pixel Drive] : "Off") 1024 steps of 3571 steps (10 bit signal input, [Sub Pixel Drive] : "On")
Recommended Brightness		500 cd/m ² (approx.65%)
Display Area (H × V)		337.9 mm × 422.4 mm
Power Supply		100-120 VAC ±10%, 50/60Hz 1.1 – 0.9 A 200-240 VAC ±10%, 50/60Hz 0.6 – 0.5 A
Power Consumption	Screen Display On	100W or less (with USB load) 90W or less (without USB load)
	Power saving mode	1.0W or less (for DVI-D single signal input, without USB load, [Input Signal] : "Manual")
	Power switch Off	0.8W or less (without USB load)
	Main Power switch Off	0W
Input Signal Connector		DVI-D connector (Applicable to HDCP) × 1
		DisplayPort (Standard V1.1a, applicable to HDCP)
Digital Signal (DVI) Transmission System		TMDS (Single Link/Dual Link)
Plug & Play		Digital (DVI-D) : VESA DDC 2B / EDID structure 1.3 Digital (DisplayPort) : VESA DisplayPort / EDID structure 1.4
Dimensions	Main unit	388.0 mm (15.3 inch) × 512.5-594.5 mm (20.2 – 23.4 inch) × 208.5 mm (8.2 inch)
	Main unit (without stand)	388.0 mm (15.3 inch) × 480 mm (18.9 inch) × 88 mm (3.46 inch)
Mass	Main unit	Approx. 10.1 kg (22.3 lbs.)
	Main unit (without stand)	Approx.7.1 kg (15.7 lbs.)
Movable range	Height adjustable stand	Tilt: 40° Up, 0° Down Swivel: 35° Right, 35° Left Adjustable height: 82 mm (3.23 inch) Rotation: 90° (counter-clockwise)

Environmental Conditions	Temperature	Operating: 0 °C - 35 °C (32 °F - 95 °F) Transportation/Storage: -20 °C - 60 °C (-4 °F - 140 °F)
	Humidity	Operating: 20% - 80% R.H. (no condensation) Transportation/Storage: 10% - 80% R.H. (no condensation)
	Pressure	Operating: 700 to 1,060 hPa Transportation/Storage: 200 to 1,060 hPa
USB	Standard	USB Specification Revision 2.0
	Port	Upstream port × 1, Downstream port × 2
	Communication Speed	480 Mbps (high), 12 Mbps (full), 1.5 Mbps (low)
	Supply current	Downstream: Max. 500mA/1 port
Classification of Equipment		Type of protection against electric shock : Class I EMC class: EN60601-1-2:2007 Group 1 Class B Classification of medical device (MDD 93/42/EEC) : Class I Mode of operation: Continuous IP Class: IPX0

Main default settings (factory settings)

CAL Switch	1-DICOM
Power Save	On
Input Selection	Auto
Logo	Off
Menu Position	Center
Language	English
Signal Selection*	Single Link
Orientation*	Portrait (HW)

* These functions cannot be initialized with the All Reset function ([page 16](#)). For information about setting these functions, refer to "3-2. Setting the Input Signals" ([page 13](#)) and "3-1. Setting Orientation" ([page 12](#)).

Outside Dimensions

Unit: mm (inch)

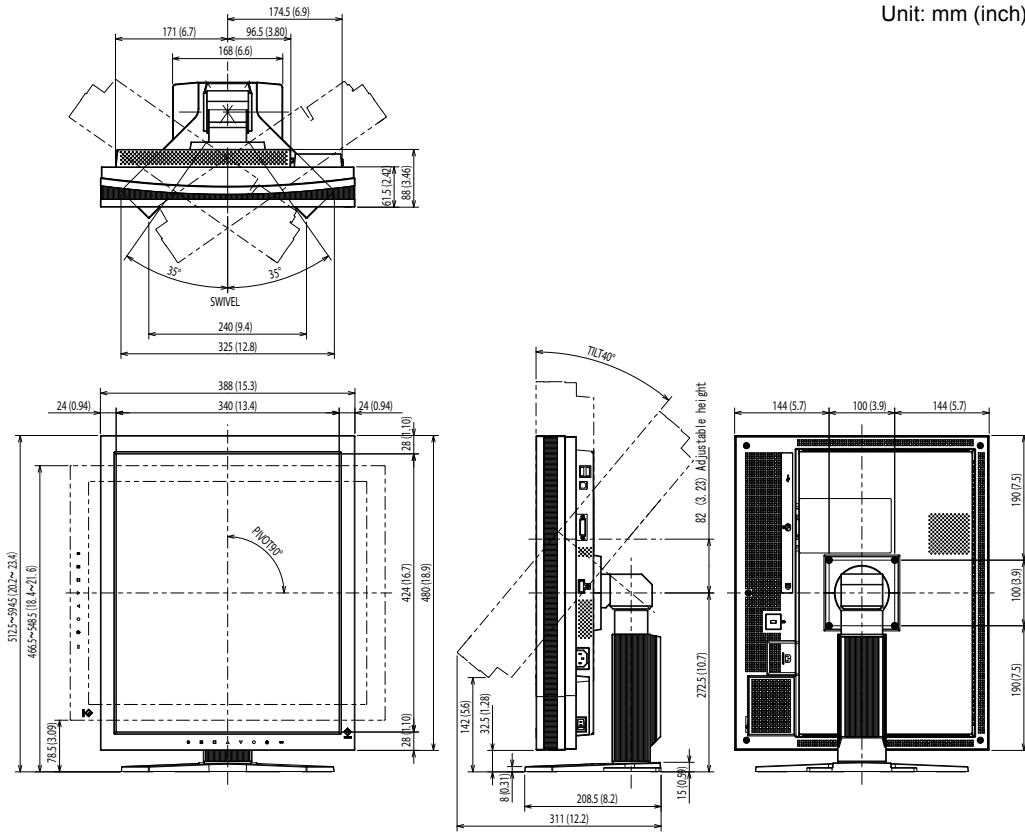

Connector Pin Assignment

- DVI-D connector

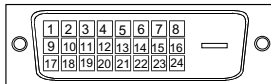

Pin No.	Signal	Pin No.	Signal	Pin No.	Signal
1	T.M.D.S. Data 2-	9	T.M.D.S. Data1-	17	T.M.D.S. Data0-
2	T.M.D.S. Data 2+	10	T.M.D.S. Data1+	18	T.M.D.S. Data0+
3	T.M.D.S. Data2/4 Shield	11	T.M.D.S. Data1/3 Shield	19	T.M.D.S. Data0/5 Shield
4	T.M.D.S. Data 4-	12	T.M.D.S. Data 3-	20	T.M.D.S. Data 5-
5	T.M.D.S. Data 4+	13	T.M.D.S. Data 3+	21	T.M.D.S. Data 5+
6	DDC Clock (SCL)	14	+5V Power	22	T.M.D.S. Clock shield
7	DDC Data (SDA)	15	Ground (return for +5V, Hsync and Vsync)	23	T.M.D.S. Clock+
8	NC*	16	Hot Plug Detect	24	T.M.D.S. Clock-

(NC*: No Connection)

- DisplayPort connector

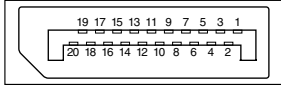

Pin No.	Signal	Pin No.	Signal	Pin No.	Signal
1	ML Lane3-	8	Ground	15	AUX CH+
2	Ground	9	ML Lane1+	16	Ground
3	ML Lane3+	10	ML Lane0-	17	AUX CH-
4	ML Lane2-	11	Ground	18	Hot Plug Detect
5	Ground	12	ML Lane0+	19	Return
6	ML Lane2+	13	CONFIG1	20	DP PWR
7	ML Lane1-	14	CONFIG2		

- USB port

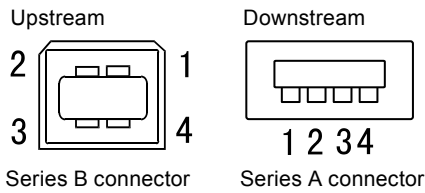

Contact No.	Signal	Remarks
1	VCC	Cable power
2	- Data	Serial data
3	+ Data	Serial data
4	Ground	Cable ground

Accessories List

Calibration Kit	EIZO "RadiCS UX1" Ver.3.4.0 or later
Network QC Management Software	EIZO "RadiNET Pro" Ver.3.4.0 or later
Cleaning Kit	EIZO "ScreenCleaner"

For the latest information about the accessories and information about the latest compatible graphics board, refer to our web site.

<http://www.eizo.com>

6-6. Glossary

DICOM (Digital Imaging and Communication in Medicine)

DICOM is a standard for digital imaging and communication for medical use developed by American College of Radiology and National Electric Manufacturers Association.

DisplayPort

DisplayPort is a next-generation digital AV interface that allows connection of the PC, audio, imaging devices, etc. to the monitor. One cable can transfer sound with images.

DVI (Digital Visual Interface)

DVI is a digital interface standard. DVI allows direct transmission of the PC's digital data without loss. This adopts the TMDS transmission system and DVI connectors. There are two types of DVI connectors. One is a DVI-D connector for digital signal input only. The other is a DVI-I connector for both digital and analog signal inputs.

DVI DMPM (DVI Digital Monitor Power Management)

DVI DMPM is a digital interface power-saving function. The "Monitor ON (operating mode)" and "Active Off (power-saving mode)" are indispensable for DVI DMPM as the monitor's power mode.

HDCP (High-bandwidth Digital Content Protection)

Digital signal coding system developed to copy-protect the digital contents, such as video, music, etc. This helps to transmit the digital contents safely by coding the digital contents sent via DVI terminal on the output side and decoding them on the input side. Any digital contents cannot be reproduced if both of the equipments on the output and input sides are not applicable to HDCP system.

Resolution

The LCD panel consists of numerous pixels of specified size, which are illuminated to form images. This monitor consists of 2048 horizontal pixels and 2560 vertical pixels. At a resolution of 2048 x 2560, all pixels are illuminated as a full screen (1:1).

TMDS (Transition Minimized Differential Signaling)

A signal transmission system for digital interface.

For U.S.A. , Canada, etc. (rated 100-120 Vac) Only

FCC Declaration of Conformity

We, the Responsible Party

EIZO NANAOTECHNOLOGIES INC.

5710 Warland Drive, Cypress, CA 90630

Phone: (562) 431-5011

declare that the product

Trade name: EIZO

Model: RadiForce GS521

is in conformity with Part 15 of the FCC Rules. Operation of this product is subject to the following two conditions: (1) this device may not cause harmful interference, and (2) this device must accept any interference received, including interference that may cause undesired operation.

This equipment has been tested and found to comply with the limits for a Class B digital device, pursuant to Part 15 of the FCC Rules. These limits are designed to provide reasonable protection against harmful interference in a residential installation. This equipment generates, uses, and can radiate radio frequency energy and, if not installed and used in accordance with the instructions, may cause harmful interference to radio communications. However, there is no guarantee that interference will not occur in a particular installation. If this equipment does cause harmful interference to radio or television reception, which can be determined by turning the equipment off and on, the user is encouraged to try to correct the interference by one or more of the following measures.

- * Reorient or relocate the receiving antenna.
- * Increase the separation between the equipment and receiver.
- * Connect the equipment into an outlet on a circuit different from that to which the receiver is connected.
- * Consult the dealer or an experienced radio/TV technician for help.

Changes or modifications not expressly approved by the party responsible for compliance could void the user's authority to operate the equipment.

Note

Use the attached specified cable below or EIZO signal cable with this monitor so as to keep interference within the limits of a Class B digital device.

- AC Cord
- Shielded Signal Cable (Enclosed)

Canadian Notice

This Class B digital apparatus complies with Canadian ICES-003.

Cet appareil numérique de la classe B est conforme à la norme NMB-003 du Canada.

EMC Information

Essential performance of RadiForce series is to display images and operate functions normally.



CAUTION

The RadiForce series requires special precautions regarding EMC and need to be installed, put into service and used according to the following information.

Do not use any cables other than the cables that provided or specified by us.

Using other cables may cause the increase of emission or decrease of immunity.

Do not put any portable and mobile RF communications equipment close to the RadiForce series. Doing so may affect the RadiForce series.

The RadiForce series should not be used adjacent to or stacked with other equipment. If adjacent or stacked use is necessary, the equipment or system should be observed to verify normal operation in the configuration in which it will be used.

Anyone who connects additional equipment to the signal input part or signal output parts, configuring a medical system, is responsible that the system complies with the requirements of IEC/EN60601-1-2.

Guidance and manufacturer's declaration - electromagnetic emissions

The RadiForce series is intended for use in the electromagnetic environment specified below.

The customer or the user of the RadiForce series should assure that it is used in such an environment.

Emission test	Compliance	Electromagnetic environment - guidance
RF emissions CISPR11/EN55011	Group 1	The RadiForce series uses RF energy only for its internal function. Therefore, its RF emission are very low and are not likely to cause any interference in nearby electronic equipment.
RF emissions CISPR11/EN55011	Class B	The RadiForce series is suitable for use in all establishments, including domestic establishments and those directly connected to the public low-voltage power supply network that supplies buildings used for domestic purposes.
Harmonic emissions IEC/EN61000-3-2	Class D	
Voltage fluctuations / flicker emissions IEC/EN61000-3-3	Complies	

Guidance and manufacturer's declaration - electromagnetic immunity

The RadiForce series is intended for use in the electromagnetic environment specified below.

The customer or the user of the RadiForce series should assure that it is used in such an environment.

Immunity test	IEC/EN60601 test level	Compliance level	Electromagnetic environment - guidance
Electrostatic discharge (ESD) IEC/EN61000-4-2	±6kV contact ±8kV air	±6kV contact ±8kV air	Floors should be wood, concrete or ceramic tile. If floors are covered with synthetic material, the relative humidity should be at least 30%.
Electrical fast transient / burst IEC/EN61000-4-4	±2kV for power supply lines ±1kV for input/output lines	±2kV for power supply lines ±1kV for input/output lines	Mains power quality should be that of a typical commercial or hospital environment.
Surge IEC/EN61000-4-5	±1kV line(s) to line(s) ±2kV line(s) to earth	±1kV line(s) to line(s) ±2kV line(s) to earth	Mains power quality should be that of a typical commercial or hospital environment.
Voltage dips, short interruptions and voltage variations on power supply input lines IEC/EN61000-4-11	<5% U_T (>95% dip in U_T) for 0.5 cycle 40% U_T (60% dip in U_T) for 5 cycles 70% U_T (30% dip in U_T) for 25 cycles <5% U_T (>95% dip in U_T) for 5sec	<5% U_T (>95% dip in U_T) for 0.5 cycle 40% U_T (60% dip in U_T) for 5 cycles 70% U_T (30% dip in U_T) for 25 cycles <5% U_T (>95% dip in U_T) for 5sec	Mains power quality should be that of a typical commercial or hospital environment. If the user of the RadiForce series requires continued operation during power mains interruptions, it is recommended that the RadiForce series be powered from an uninterruptible power supply or a battery.
Power frequency (50/60Hz) magnetic field IEC/EN61000-4-8	3A/m	3A/m	Power frequency magnetic fields should be at levels characteristic of a typical location in a typical commercial or hospital environment.

NOTE U_T is the a.c. mains voltage prior to application of the test level.

Guidance and manufacturer's declaration - electromagnetic immunity			
The RadiForce series is intended for use in the electromagnetic environment specified below. The customer or the user of the RadiForce series should assure that it is used in such an environment.			
Immunity test	IEC/EN60601 test level	Compliance level	Electromagnetic environment - guidance
Conducted RF IEC/EN61000-4-6	3Vrms 150kHz to 80MHz	3Vrms	Portable and mobile RF communications equipment should be used no closer to any part of the RadiForce series, including cables, than the recommended separation distance calculated from the equation applicable to the frequency of the transmitter. Recommended Separation distance $d = 1.2 \sqrt{P}$ $d = 1.2 \sqrt{P}$, 80MHz to 800MHz $d = 2.3 \sqrt{P}$, 800MHz to 2.5GHz Where "P" is the maximum output power rating of the transmitter in watts (W) according to the transmitter manufacturer and "d" is the recommended separation distance in meters (m). Field strengths from fixed RF transmitters, as determined by an electromagnetic site survey ^a , should be less than the compliance level in each frequency range ^b . Interference may occur in the vicinity of equipment marked with the following symbol. 
Radiated RF IEC/EN61000-4-3	3V/m 80MHz to 2.5GHz	3V/m	
NOTE 1 At 80 MHz and 800 MHz, the higher frequency range applies.			
NOTE 2 These guidelines may not apply in all situations. Electromagnetic propagation is affected by absorption and reflection from structures, objects and people.			
^a Field strengths from fixed transmitters, such as base stations for radio (cellular/cordless) telephones and land mobile radios, amateur radio, AM and FM radio broadcast and TV broadcast cannot be predicted theoretically with accuracy. To assess the electromagnetic environment due to fixed RF transmitters, an electromagnetic site survey should be considered. If the measured field strength in the location in which the RadiForce series is used exceeds the applicable RF compliance level above, the RadiForce series should be observed to verify normal operation. If abnormal performance is observed, additional measures may be necessary, such as reorienting or relocating the RadiForce series.			
^b Over the frequency range 150 kHz to 80 MHz, field strengths should be less than 3 V/m.			

Recommended separation distances between portable and mobile RF communications equipment and the RadiForce Series

The RadiForce series is intended for use in an electromagnetic environment in which radiated RF disturbances are controlled. The customer or the user of the RadiForce series can help prevent electromagnetic interference by maintaining a minimum distance between portable and mobile RF communications equipment (transmitters) and the RadiForce series as recommended below, according to the maximum output power of the communications equipment.

Rated maximum output power of transmitter W	Separation distance according to frequency of transmitter m		
	150kHz to 80MHz $d = 1.2 \sqrt{P}$	80MHz to 800MHz $d = 1.2 \sqrt{P}$	800MHz to 2.5GHz $d = 2.3 \sqrt{P}$
0.01	0.12	0.12	0.23
0.1	0.38	0.38	0.73
1	1.2	1.2	2.3
10	3.8	3.8	7.3
100	12	12	23

For transmitters rated at a maximum output power not listed above, the recommended separation distance “d” in meters (m) can be estimated using the equation applicable to the frequency of the transmitter, where “P” is the maximum output power rating of the transmitter in watts (W) according to the transmitter manufacturer.

NOTE 1 At 80 MHz and 800 MHz, the separation distance for the higher frequency range applies.

NOTE 2 These guidelines may not apply in all situations. Electromagnetic propagation is affected by absorption and reflection from structures, objects and people.

Cable length		
Power Cord :	Accessory	2.0m
Signal Cable (DD200-DL) :	Accessory	2.0m
Signal Cable (PP200) :	Accessory	2.0m
USB Cable (MD-C93) :	Accessory	1.8m

LIMITED WARRANTY

EIZO NANO CORPORATION (hereinafter referred to as “EIZO”) and distributors authorized by EIZO (hereinafter referred to as the “Distributors”) warrant, subject to and in accordance with the terms of this limited warranty (hereinafter referred to as the “Warranty”), to the original purchaser (hereinafter referred to as the “Original Purchaser”) who purchased the product specified in this document (hereinafter referred to as the “Product”) from EIZO or Distributors, that EIZO and Distributors shall, at their sole discretion, either repair or replace the Product at no charge if the Original Purchaser becomes aware within the Warranty Period (defined below) that (i) the Product malfunctions or is damaged in the course of normal use of the Product in accordance with the description in the instruction manual attached to the Product (hereinafter referred to as the “User’s Manual”), or (ii) the LCD panel and brightness of the Product cannot maintain the recommended brightness specified in the User’s Manual in the course of normal use of the Product in accordance with the description of the User’s Manual.

The period of this Warranty is five (5) years from the date of purchase of the Product (hereinafter referred to as the “Warranty Period”), provided that the Warranty Period for the LCD panel is limited to five (5) years from the date of purchase of the Product subject to the usage time being less than or equal to 30,000 hours. The brightness of the Product shall be warranted only if the Product has been used within the recommended brightness of described in the User’s Manual and the Warranty Period for the brightness is limited to five (5) years from the date of purchase of the Product subject to the usage time being less than or equal to 30,000 hours. EIZO and Distributors shall bear no liability or obligation with regard to the Product in relation to the Original Purchaser or any third parties other than as provided under this Warranty.

EIZO and Distributors will cease to hold or store any parts of the Product upon expiration of seven (7) years after the production of such parts is discontinued. In repairing the monitor, EIZO and Distributors will use renewal parts which comply with our QC standards.

The Warranty is valid only in the countries or territories where the Distributors are located. The Warranty does not restrict any legal rights of the Original Purchaser.

Notwithstanding any other provision of this Warranty, EIZO and Distributors shall have no obligation under this Warranty whatsoever in any of the cases as set forth below:

- (a) Any defect of the Product caused by freight damage, modification, alteration, abuse, misuse, accident, incorrect installation, disaster, faulty maintenance and/or improper repair by third party other than EIZO and Distributors;
- (b) Any incompatibility of the Product due to possible technical innovations and/or regulations;
- (c) Any deterioration of the sensor;
- (d) Any deterioration of display performance caused by the deterioration of expendable parts such as the LCD panel and/or backlight, etc. (e.g. changes in color, changes in color uniformity, defects in pixels including burnt pixels, etc.);
- (e) Any deterioration of the Product caused by the use at higher brightness than the recommended brightness described in the User’s Manual;
- (f) Any defect of the Product caused by external equipment;
- (g) Any defect of the Product on which the original serial number has been altered or removed;
- (h) Any normal deterioration of the product, particularly that of consumables, accessories, and/or attachments (e.g. buttons, rotating parts, cables, User’s Manual, etc.); and
- (i) Any deformation, discoloration, and/or warp of the exterior of the product including that of the surface of the LCD panel.

To obtain service under the Warranty, the Original Purchaser must deliver the Product, freight prepaid, in its original package or other adequate package affording an equal degree of protection, assuming the risk of damage and/or loss in transit, to the local Distributor. The Original Purchaser must present proof of purchase of the Product and the date of such purchase when requesting services under the Warranty.

The Warranty Period for any replaced and/or repaired product under this Warranty shall expire at the end of the original Warranty Period.

EIZO OR DISTRIBUTORS ARE NOT RESPONSIBLE FOR ANY DAMAGE TO, OR LOSS OF, DATA OR OTHER INFORMATION STORED IN ANY MEDIA OR ANY PART OF ANY PRODUCT RETURNED TO EIZO OR DISTRIBUTORS FOR REPAIR.

EIZO AND DISTRIBUTORS MAKE NO FURTHER WARRANTIES, EXPRESSED OR IMPLIED, WITH RESPECT TO THE PRODUCT AND ITS QUALITY, PERFORMANCE, MERCHANTABILITY OR FITNESS FOR ANY PARTICULAR USE. IN NO EVENT SHALL EIZO OR DISTRIBUTORS BE LIABLE FOR ANY INCIDENTAL, INDIRECT, SPECIAL, CONSEQUENTIAL OR OTHER DAMAGE WHATSOEVER (INCLUDING, WITHOUT LIMITATION, DAMAGES FOR LOSS OF PROFIT, BUSINESS INTERRUPTION, LOSS OF BUSINESS INFORMATION, OR ANY OTHER PECUNIARY LOSS) ARISING OUT OF THE USE OR INABILITY TO USE THE PRODUCT OR IN ANY CONNECTION WITH THE PRODUCT, WHETHER BASED ON CONTRACT, TORT, NEGLIGENCE, STRICT LIABILITY OR OTHERWISE, EVEN IF EIZO OR DISTRIBUTORS HAVE BEEN ADVISED OF THE POSSIBILITY OF SUCH DAMAGES. THIS EXCLUSION ALSO INCLUDES ANY LIABILITY WHICH MAY ARISE OUT OF THIRD PARTY CLAIMS AGAINST THE ORIGINAL PURCHASER. THE ESSENCE OF THIS PROVISION IS TO LIMIT THE POTENTIAL LIABILITY OF EIZO AND DISTRIBUTORS ARISING OUT OF THIS LIMITED WARRANTY AND/OR SALES.

BEGRENZTE GARANTIE

EIZO NANA O CORPORATION (im Weiteren als „**EIZO**“ bezeichnet) und die Vertragsimporteure von EIZO (im Weiteren als „**Vertrieb(e)**“ bezeichnet) garantieren dem ursprünglichen Käufer (im Weiteren als „**Erstkäufer**“ bezeichnet), der das in diesem Dokument vorgegebene Produkt (im Weiteren als „**Produkt**“ bezeichnet) von EIZO oder einem Vertrieb erworben hat, gemäß den Bedingungen dieser beschränkten Garantie (im Weiteren als „**Garantie**“ bezeichnet), dass EIZO und der Vertrieb nach eigenem Ermessen das Produkt entweder kostenlos reparieren oder austauschen, falls der Erstkäufer innerhalb der Garantiefrist (weiter unten festgelegt) entweder (i) eine Fehlfunktion bzw. Beschädigung des Produkts feststellt, die während des normalen Gebrauchs des Produkts gemäß den Anweisungen des zum Lieferumfang des Produkts gehörenden Benutzerhandbuchs (im Weiteren als „**Benutzerhandbuch**“ bezeichnet) aufgetreten ist, oder (ii) das LCD-Panel und die Helligkeit des Produkts während des normalen Gebrauchs des Produkts gemäß den Anweisungen des Benutzerhandbuchs nicht die im Benutzerhandbuch genannte empfohlene Helligkeit aufrecht erhalten können.

Die Dauer der Garantieleistung beträgt fünf (5) Jahre ab dem Kaufdatum des Produkts (im Weiteren als „**Garantiefrist**“ bezeichnet), wobei die Garantiefrist für das LCD-Panel auf fünf (5) Jahre ab dem Kaufdatum oder maximal 30.000 Betriebsstunden beschränkt ist. Die Helligkeit des Produkts wird nur garantiert, wenn das Produkt innerhalb der empfohlenen Helligkeit wie im Benutzerhandbuch beschrieben verwendet wird, und die Dauer der Garantiefrist beträgt fünf (5) Jahre ab dem Kaufdatum des Produkts, wobei die Benutzungszeit des Produkts auf maximal 30.000 Betriebsstunden beschränkt ist. EIZO und die Vertriebe übernehmen über den Rahmen dieser Garantie hinaus hinsichtlich des Produkts keinerlei Haftung oder Verpflichtung dem Erstkäufer oder Dritten gegenüber.

EIZO und die Vertriebe verpflichten sich, Ersatzteile für das Produkt über einen Zeitraum von sieben (7) Jahren nach Einstellung der Produktion der Ersatzteile zu lagern bzw. anzubieten. EIZO und seine Vertriebspartner verpflichten sich, bei einer etwaigen Reparatur des Monitors ausschließlich Produkte gemäß den EIZO-Qualitätssicherungsstandards zu verwenden.

Diese Garantie gilt nur in Ländern oder Gebieten, in denen sich Vertriebe befinden. Die gesetzlichen Gewährleistungsrechte des Erstkäufers gegenüber dem Verkäufer werden durch diese Garantie nicht berührt.

EIZO und die Vertriebe besitzen im Rahmen dieser Garantie keinerlei Verpflichtung in den folgenden Fällen:

- (a) Produktdefekte, die auf Frachtschäden, Modifikation, Nachgestaltung, Missbrauch, Fehlbedienung, Unfälle, unsachgemäße Installation, Naturkatastrophen, fehlerhafte Wartung und/oder unsachgemäße Reparatur durch eine andere Partei als EIZO und die Vertriebe zurückzuführen sind.
- (b) Eine Inkompatibilität des Produkts aufgrund von technischen Neuerungen und/oder neuen Bestimmungen, die nach dem Kauf in Kraft treten.
- (c) Jegliche Verschlechterung des Sensors;
- (d) Jegliche Verschlechterung der Bildschirmleistung, die durch Verschleißteile wie den LCD-Panel und/oder die Hintergrundbeleuchtung usw. hervorgerufen werden (z.B. Veränderungen von Farbe oder Farbverteilung, Pixeldefekte einschließlich von durchgebrannten Pixeln usw.).
- (e) Jegliche Abnutzung des Produkts, die auf einen Gebrauch mit einer höheren Helligkeit als die im Benutzerhandbuch genannte empfohlene Helligkeit zurückzuführen ist.
- (f) Produktdefekte, die durch externe Geräte verursacht werden.
- (g) Jeglicher Defekt eines Produkts, dessen ursprüngliche Seriennummer geändert oder entfernt wurde.
- (h) Normale Abnutzung des Produkts, insbesondere von Verbrauchsteilen, Zubehörteilen und/oder Beilagen (z.B. Tasten, drehbare Teile, Kabel, Benutzerhandbuch usw.); sowie
- (i) Verformungen, Verfärbungen und/oder Verziehungen am Produktäußeren, einschließlich der Oberfläche des LCD-Panels.

Bei Inanspruchnahme der Garantieleistung ist der Erstkäufer verpflichtet, das Produkt auf eigene Kosten und in der Originalverpackung bzw. einer anderen geeigneten Verpackung, die einen gleichwertigen Schutz gegen Transportschäden bietet, an den örtlichen Vertrieb zu übersenden, wobei der Erstkäufer das Transportrisiko gegenüber Schäden und/oder Verlust trägt. Zum Zeitpunkt der Inanspruchnahme der Garantieleistung muss der Erstkäufer einen Verkaufsbeleg vorweisen, auf dem das Kaufdatum angegeben ist.

Die Garantiefrist für ein im Rahmen dieser Garantie ausgetauschtes und/oder repariertes Produkt erlischt nach Ablauf der ursprünglichen Garantiefrist.

EIZO ODER DIE EIZO-VERTRAGSIMPORTEURE HAFTEN NICHT FÜR ZERSTÖRTE DATENBESTÄNDE ODER DIE KOSTEN DER WIEDERBESCHAFFUNG DIESER DATENBESTÄNDE AUF JEDLICHEN DATENTRÄGERN ODER TEILEN DES PRODUKTS, DIE IM RAHMEN DER GARANTIE BEI EIZO ODER DEN EIZO-VERTRAGSIMPORTEUREN ZUR REPARATUR EINGEREICHT WURDEN.

EIZO UND DIE EIZO-VERTRAGSIMPORTEURE GEBEN WEDER EXPLIZITE NOCH IMPLIZITE GARANTIEEN IN BEZUG AUF DIESES PRODUKT UND SEINE QUALITÄT, LEISTUNG, VERKÄUFLICHKEIT ODER EIGNUNG FÜR EINEN BESTIMMTEN ZWECK. AUF KEINEN FALL SIND EIZO ODER DIE EIZO-VERTRAGSIMPORTEURE VERANTWORTLICH FÜR JEDLICHE ZUFÄLLIGE, INDIREKTE, SPEZIELLE, FOLGE- ODER ANDERE SCHÄDEN JEDLICHER ART (EINSCHLIESSLICH OHNE JEDE BEGRENZUNG SCHÄDEN BEZÜGLICH PROFITVERLUST, GESCHÄFTSUNTERBRECHUNG, VERLUST VON GESCHÄFTSINFORMATION ODER JEDLICHE ANDEREN FINANZIELLEN EINBUSSEN), DIE DURCH DIE VERWENDUNG DES PRODUKTES ODER DIE UNFÄHIGKEIT ZUR VERWENDUNG DES PRODUKTES ODER IN JEDLICHER BEZIEHUNG MIT DEM PRODUKT, SEI ES BASIEREND AUF VERTRAG, SCHADENSERSATZ, NACHLAESSIGKEIT, STRIKTE HAFTPFLICHT ODER ANDEREN FORDERUNGEN ENTSTEHEN, AUCH WENN EIZO UND DIE EIZO-VERTRAGSIMPORTEURE IM VORAUS ÜBER DIE MÖGLICHKEIT SOLCHER SCHÄDEN INFORMIERT WURDEN. DIESER AUSSCHLUSS ENTHÄLT AUCH JEDE HAFTPFLICHT, DIE AUS FORDERUNGEN DRITTER GEGEN DEN ERSTKÄUFER ENTSTEHEN KANN. ZWECK DIESER KLAUSEL IST ES, DIE HAFTUNG VON EIZO UND DEN VERTRIEBEN GEGENÜBER FORDERUNGEN ZU BEGRENZEN, DIE AUS DIESER BESCHRÄNKTEN GARANTIE UND/ODER DEM VERKAUF ENTSTEHEN KÖNNEN.

GARANTIE LIMITÉE

EIZO NANA O CORPORATION (ci-après dénommé « **EIZO** ») et les distributeurs autorisés par EIZO (ci-après dénommés « **Distributeurs** »), sous réserve et conformément aux termes de cette garantie limitée (ci-après dénommée « **Garantie** »), garantissent à l'acheteur initial (ci-après dénommé « **Acheteur initial** ») du produit spécifié dans la présente (ci-après dénommé « **Produit** ») acheté auprès d'EIZO ou de Distributeurs agréés EIZO, que EIZO et ses Distributeurs auront pour option de réparer ou remplacer gratuitement le Produit si l'Acheteur initial constate, pendant la Période de garantie (définie ci-dessous), (i) qu'il y a un dysfonctionnement ou que le Produit a subi un dommage dans le cadre d'une utilisation normale du Produit conformément à la description du mode d'emploi qui accompagne le Produit (ci-après dénommé « **Manuel d'utilisateur** »), ou (ii) que le panneau LCD et la luminosité du Produit ne peuvent pas maintenir la luminosité recommandée spécifiée dans le Manuel d'utilisation dans le cadre d'une utilisation normale du Produit, conformément à la description du Manuel d'utilisation.

La période de cette Garantie est de cinq (5) ans à compter de la date d'achat du Produit (ci-après dénommée « **Période de Garantie** ») sous réserve que la Période de Garantie de l'affichage LCD soit limitée à cinq (5) ans à compter de la date d'achat du Produit à condition que la période d'utilisation soit inférieure ou égale à 30 000 heures. La luminosité du Produit ne sera garantie que si le Produit a été utilisé dans les conditions de luminosité recommandées et décrites dans le Manuel de l'Usager et que la Période de Garantie de la luminosité est limitée à cinq (5) ans à compter de la date d'achat du Produit et sous réserve d'une période d'utilisation inférieure ou égale à 30 000 heures. EIZO et ses Distributeurs déclinent toute responsabilité ou obligation concernant ce Produit face à l'Acheteur initial ou à toute autre personne à l'exception de celles stipulées dans la présente Garantie.

EIZO et ses Distributeurs cesseront de tenir ou conserver en stock toute pièce de ce Produit après l'expiration de la période de sept (7) ans suivant l'arrêt de la production de telles pièces. Pour réparer le moniteur, EIZO et ses distributeurs utiliseront des pièces de rechange conformes à nos normes de contrôle qualité.

La Garantie est valable uniquement dans les pays ou les territoires où se trouvent les Distributeurs. La Garantie ne limite aucun des droits reconnus par la loi à l'Acheteur initial.

Nonobstant toute autre clause de cette Garantie, EIZO et ses Distributeurs n'auront d'obligation dans le cadre de cette Garantie pour aucun des cas énumérés ci-dessous :

- (a) Tout défaut du Produit résultant de dommages occasionnés lors du transport, d'une modification, d'une altération, d'un abus, d'une mauvaise utilisation, d'un accident, d'une installation incorrecte, d'un désastre, d'un entretien et/ou d'une réparation incorrects effectués par une personne autre que EIZO ou ses Distributeurs ;
- (b) Toute incompatibilité du Produit résultant d'améliorations techniques et/ou réglementations possibles ;
- (c) Toute détérioration du capteur ;
- (d) Toute détérioration des performances d'affichage causée par la détérioration des éléments consommables tels que le panneau LCD et/ou le rétroéclairage, etc. (par exemple, des modifications de couleur, des modifications de l'uniformité des couleurs, des défauts de pixels y compris des pixels brûlés, etc.);
- (e) Toute détérioration du Produit causée par l'utilisation d'une luminosité plus élevée que la luminosité recommandée, telle que décrite dans le Manuel d'utilisation;
- (f) Tout défaut du Produit causé par un appareil externe ;
- (g) Tout défaut d'un Produit sur lequel le numéro de série original a été altéré ou supprimé ;
- (h) Toute détérioration normale du Produit, particulièrement celle des consommables, des accessoires et/ou des pièces reliées au Produit (touches, éléments pivotants, câbles, Manuel d'utilisation etc.), et
- (i) Toute déformation, décoloration, et/ou gondolage de l'extérieur du Produit, y compris celle de la surface du panneau LCD.

Pour bénéficier d'un service dans le cadre de cette Garantie, l'Acheteur initial doit renvoyer le Produit port payé, dans son emballage d'origine ou tout autre emballage approprié offrant un degré de protection équivalent, au Distributeur local, et assumera la responsabilité des dommages et/ou perte possibles lors du transport. L'Acheteur initial doit présenter une preuve d'achat du Produit comprenant sa date d'achat pour bénéficier de ce service dans le cadre de la Garantie.

La Période de garantie pour tout Produit remplacé et/ou réparé dans le cadre de cette Garantie expirera à la fin de la Période de garantie initiale.

EIZO OU SES DISTRIBUTEURS NE SAURAIENT ÊTRE TENUS RESPONSABLES DES DOMMAGES OU PERTES DE DONNÉES OU D'AUTRES INFORMATIONS STOCKÉES DANS UN MÉDIA QUELCONQUE OU UNE AUTRE PARTIE DU PRODUIT RENVOYÉ À EIZO OU AUX DISTRIBUTEURS POUR RÉPARATION.

AUCUNE AUTRE GARANTIE, EXPLICITE OU TACITE, N'EST OFFERTE PAR EIZO ET SES DISTRIBUTEURS CONCERNANT LE PRODUIT ET SES QUALITÉS, PERFORMANCES, QUALITÉ MARCHANDE OU ADAPTATION À UN USAGE PARTICULIER. EN AUCUN CAS, EIZO OU SES DISTRIBUTEURS NE SERONT RESPONSABLES DES DOMMAGES FORTUITS, INDIRECTS, SPÉCIAUX, INDUITS, OU DE TOUT AUTRE DOMMAGE QUEL QU'IL SOIT (Y COMPRIS, SANS LIMITATION, LES DOMMAGES RÉSULTANT D'UNE PERTE DE PROFIT, D'UNE INTERRUPTION D'ACTIVITÉS, D'UNE PERTE DE DONNÉES COMMERCIALES, OU DE TOUT AUTRE MANQUE À GAGNER) RÉSULTANT DE L'UTILISATION OU DE L'INCAPACITÉ D'UTILISER LE PRODUIT OU AYANT UN RAPPORT QUELCONQUE AVEC LE PRODUIT, QUE CE SOIT SUR LA BASE D'UN CONTRAT, D'UN TORT, D'UNE NÉGLIGENCE, D'UNE RESPONSABILITÉ STRICTE OU AUTRE, MÊME SI EIZO OU SES DISTRIBUTEURS ONT ÉTÉ AVERTIS DE LA POSSIBILITÉ DE TELS DOMMAGES. CETTE LIMITATION INCLUT AUSSI TOUTE RESPONSABILITÉ QUI POURRAIT ÊTRE SOULEVÉE LORS DES RÉCLAMATIONS D'UN TIERS CONTRE L'ACHETEUR INITIAL. L'ESSENCE DE CETTE CLAUSE EST DE LIMITER LA RESPONSABILITÉ POTENTIELLE DE EIZO ET DE SES DISTRIBUTEURS RÉSULTANT DE CETTE GARANTIE LIMITÉE ET/OU DES VENTES.

GARANTÍA LIMITADA

EIZO NANA CORPORATION (en lo sucesivo “EIZO”) y sus distribuidores autorizados por EIZO (en lo sucesivo los “Distribuidores”), con arreglo y de conformidad con los términos de esta garantía limitada (en lo sucesivo la “Garantía”), garantizan al comprador original (en lo sucesivo el “Comprador original”) que compró el producto especificado en este documento (en lo sucesivo el “Producto”) a EIZO o a sus Distribuidores, que EIZO y sus Distribuidores, a su propio criterio, repararán o sustituirán el Producto de forma gratuita si el Comprador original detecta dentro del periodo de la Garantía (indicado posteriormente) que: (i) el Producto no funciona correctamente o que se ha averiado durante el uso normal del mismo de acuerdo con las indicaciones del manual de instrucciones suministrado con el Producto (en lo sucesivo el “Manual del usuario”); o (ii) el panel LCD y el brillo del Producto no pueden mantener el brillo recomendado que se especifica en el Manual del usuario durante el uso normal del Producto de acuerdo con las descripciones del Manual del usuario.

El período de validez de esta Garantía es de cinco (5) años desde la fecha de compra del Producto (en adelante, “Período de garantía”), teniendo en cuenta que el Período de garantía del panel LCD está limitado a cinco (5) años desde la fecha de compra del Producto siempre que el tiempo de utilización sea inferior o igual a 30.000 horas. El brillo del Producto sólo estará garantizado si el Producto se ha utilizado dentro de los límites de brillo descritos en el Manual del usuario y el Período de garantía del brillo está limitado a cinco (5) años desde la fecha de compra del Producto siempre que el tiempo de utilización sea inferior o igual a 30.000 horas. EIZO y sus Distribuidores no tendrán ninguna responsabilidad ni obligación con respecto al Producto para con el Comprador original ni con terceros que no sean las estipuladas en la presente Garantía.

EIZO y sus Distribuidores no estarán obligados a suministrar cualquier recambio del Producto una vez pasados siete (7) años desde que se deje de fabricar el mismo. Para la reparación del monitor, EIZO y los distribuidores utilizarán repuestos que cumplan con nuestros estándares de control de calidad.

La Garantía es válida sólo en los países y territorios donde están ubicados los Distribuidores. La Garantía no restringe ningún derecho legal del Comprador original.

A pesar de las estipulaciones de esta Garantía, EIZO y sus Distribuidores no tendrán obligación alguna bajo esta Garantía en ninguno de los casos expuestos a continuación:

- (a) Cualquier defecto del Producto causado por daños en el transporte, modificación, alteración, abuso, uso incorrecto, accidente, instalación incorrecta, desastre, mantenimiento incorrecto y/o reparación indebida realizada por un tercero que no sea EIZO o sus Distribuidores.
- (b) Cualquier incompatibilidad del Producto debida a posibles innovaciones técnicas y/o reglamentaciones.
- (c) Cualquier deterioro del sensor;
- (d) Cualquier deterioro en el rendimiento de la visualización causado por fallos en las piezas consumibles como el panel de cristal líquido y/o la “Backlight”, etc. (i.e.: cambios de color, cambios de uniformidad del color, defectos de píxeles, incluyendo píxeles muertos, etc.).
- (e) Cualquier deterioro del Producto causado por el uso continuado con un brillo superior al recomendado en el Manual del usuario.
- (f) Cualquier defecto del Producto causado por un equipo externo.
- (g) Cualquier defecto del Producto en el que haya sido alterado o borrado el número de serie original.
- (h) Cualquier deterioro normal del Producto, y en particular de las piezas consumibles, accesorios y demás (p. ej. botones, piezas giratorias, cables, Manual del usuario, etc.).
- (i) Cualquier deformación, decoloración y/o alabeo del exterior del Producto incluida la superficie del panel LCD.

Para obtener servicio en los términos de esta Garantía, el Producto deberá ser enviado por el Comprador original, a su Distribuidor local, con el transporte previamente pagado, en el embalaje original u otro embalaje adecuado que ofrezca el mismo grado de protección, asumiendo el riesgo de daños y/o pérdida del Producto durante el transporte. El Comprador original deberá presentar un comprobante de compra del Producto en el que se refleje la fecha de compra del mismo cuando lo solicite el servicio de Garantía.

El Período de garantía para cualquier Producto reemplazado y/o reparado en los términos de esta Garantía expirará al vencer el Período de garantía original.

EIZO O LOS DISTRIBUIDORES AUTORIZADOS DE EIZO NO SE RESPONSABILIZAN DE NINGÚN DAÑO O PÉRDIDA QUE PUEDAN SUFRIR LOS DATOS U OTRA INFORMACIÓN ALMACENADA EN CUALQUIER MEDIO O CUALQUIER PARTE DE CUALQUIER PRODUCTO DEVUELTO A EIZO O A LOS DISTRIBUIDORES DE EIZO PARA SU REPARACIÓN.

EIZO Y LOS DISTRIBUIDORES AUTORIZADOS DE EIZO NO OFRECEN NINGUNA OTRA GARANTÍA, IMPLÍCITA NI EXPLÍCITA, CON RESPECTO AL PRODUCTO Y A SU CALIDAD, RENDIMIENTO, COMERCIABILIDAD E IDONEIDAD PARA CUALQUIER USO EN PARTICULAR. EN NINGÚN CASO SERÁN EIZO O LOS DISTRIBUIDORES AUTORIZADOS DE EIZO RESPONSABLES DE NINGÚN DAÑO EMERGENTE, INDIRECTO, ESPECIAL, INHERENTE O CUALQUIERA QUE SEA (INCLUYENDO, SIN LIMITACIÓN, DAÑOS POR LUCRO CESANTE, INTERRUPCIÓN DE LA ACTIVIDAD COMERCIAL, PÉRDIDA DE INFORMACIÓN COMERCIAL O CUALQUIER OTRA PÉRDIDA PECUNIARIA) QUE SE DERIVE DEL USO O IMPOSIBILIDAD DE USO DEL PRODUCTO O EN RELACIÓN CON EL PRODUCTO, YA SEA BASADO EN CONTRATO, POR AGRAVIO, NEGLIGENCIA, ESTRICTA RESPONSABILIDAD O CUALQUIERA QUE SEA, AUN CUANDO SE HAYA ADVERTIDO A EIZO O A LOS DISTRIBUIDORES DE EIZO DE LA POSIBILIDAD DE TALES DAÑOS. ESTA EXCLUSIÓN TAMBIÉN ABARCA CUALQUIER RESPONSABILIDAD QUE PUEDA DERIVARSE DE RECLAMACIONES HECHAS POR UN TERCERO CONTRA EL COMPRADOR ORIGINAL. LA ESENCIA DE ESTA ESTIPULACIÓN ES LIMITAR LA RESPONSABILIDAD POTENCIAL DE EIZO Y LOS DISTRIBUIDORES QUE PUDIERA DERIVARSE DE ESTA GARANTÍA LIMITADA Y/O VENTAS.

GARANZIA LIMITATA

EIZO NANO CORPORATION (a cui si farà riferimento da qui in poi con “EIZO”) ed i Distributori autorizzati da EIZO (a cui si farà riferimento da qui in poi con “Distributori”) garantiscono, secondo i termini di questa garanzia limitata (a cui si farà riferimento da qui in poi con “Garanzia”) all’acquirente originale (a cui si farà riferimento da qui in poi con “Acquirente originale”) che ha acquistato il prodotto specificato in questo documento (a cui si farà riferimento da qui in poi con “Prodotto”) da EIZO o dai suoi Distributori, che EIZO e i distributori, a loro discrezione, ripareranno o sostituiranno il Prodotto senza addebito se l’Acquirente originale trova, entro il periodo della Garanzia (definito sotto), che (i) il Prodotto malfunziona e si è danneggiato nel corso del suo normale utilizzo osservando le indicazioni del manuale di istruzioni allegato al Prodotto (a cui si farà riferimento da qui in poi con “Manuale utente”), o che (ii) il pannello LCD e la luminosità del Prodotto non possono mantenere la luminosità raccomandata specificata nel Manuale utente nel corso del normale utilizzo del Prodotto osservando le indicazioni del Manuale utente.

La presente Garanzia è limitata a cinque (5) anni dalla data di acquisto del prodotto (di qui in avanti “Periodo di Garanzia”), tenendo però presente che il Periodo di garanzia del pannello LCD del Prodotto è limitato a cinque (5) anni dalla data d’acquisto del Prodotto a condizione che il tempo di utilizzo sia inferiore o uguale a 30000 ore. La luminosità del Prodotto verrà garantita solo se il Prodotto è stato usato entro la luminosità raccomandata nel Manuale utente e se il Periodo di garanzia per la luminosità è limitato a cinque (5) anni dalla data di acquisto del Prodotto a condizione che il tempo di utilizzo sia inferiore o uguale a 30000 ore. EIZO e i suoi Distributori non si assumono alcuna responsabilità e non hanno alcun obbligo riguardo al Prodotto verso l’Acquirente originale o terzi diversi da quelli relativi a questa Garanzia.

EIZO e i suoi Distributori cesseranno di tenere o di conservare qualsiasi ricambio del Prodotto allo scadere di sette (7) anni dopo che la produzione di tali ricambi è stata terminata. Per la riparazione del monitor, EIZO e i Distributori utilizzeranno parti di ricambio conformi ai nostri standard di controllo della qualità.

La Garanzia è valida soltanto nei paesi dove ci sono i Distributori EIZO. La Garanzia non limita alcun diritto legale dell’Acquirente originale.

Indipendentemente da qualsiasi altra condizione di questa Garanzia, EIZO e i suoi Distributori non avranno alcun obbligo derivante da questa Garanzia in ognuno dei casi elencati di seguito:

- (a) Qualsiasi difetto del Prodotto causato da danni di trasporto, modifiche, alterazioni, abusi, usi impropri, incidenti, installazione errata, calamità, manutenzione errata e/o riparazioni improprie eseguite da terze parti che non siano EIZO o i suoi Distributori.
- (b) Qualsiasi incompatibilità del Prodotto dovuta a possibili innovazioni tecniche e/o normative.
- (c) Qualsiasi deterioramento del sensore;
- (d) Qualsiasi deterioramento delle prestazioni dello schermo causato dal deterioramento delle parti consumabili, come il pannello LCD e/o la retroilluminazione, ecc. (per esempio: i cambiamenti di colore, cambiamenti di uniformità del colore, difetti dei pixel, inclusi i pixel bruciati, ecc.).
- (e) Qualsiasi deterioramento del Prodotto causato dal suo utilizzo ad una luminosità più alta di quella raccomandata nel Manuale utente.
- (f) Qualsiasi difetto del Prodotto causato da apparecchiature esterne.
- (g) Qualsiasi difetto del Prodotto in cui il numero di serie originale sia stato alterato o rimosso.
- (h) Qualsiasi normale deterioramento del Prodotto, in particolar modo nelle sue parti di consumo, accessori, e/o attacchi (per esempio: tasti, parti rotanti, cavi, Manuale dell’utente, ecc.).
- (i) Qualsiasi tipo di deformazione, scolorimento, e/o di involucro esterno del Prodotto inclusa la superficie del pannello LCD.

Per ricevere assistenza tecnica con questa Garanzia, l’Acquirente originale deve inviare il Prodotto, con trasporto pre-pagato, nella sua confezione originale o altra confezione adeguata che fornisce un livello analogo di protezione, assumendosi il rischio di danni e/o perdita in transito, al Distributore locale. L’Acquirente originale deve presentare la prova di acquisto che stabilisce la data di acquisto del Prodotto quando richiede servizio sotto Garanzia.

Il Periodo di garanzia per qualsiasi Prodotto sostituito e/o riparato sotto questa Garanzia scade alla fine del Periodo di garanzia originale.

EIZO O I SUOI DISTRIBUTORI NON SONO RESPONSABILI PER QUALSIASI DANNO O PERDITA DI DATI O ALTRE INFORMAZIONI MEMORIZZATI SU QUALSIASI SUPPORTO O QUALSIASI PARTE DI QUALSIASI PRODOTTO INVIATO A EIZO O I SUOI DISTRIBUTORI PER RIPARAZIONI.

EIZO E I SUOI DISTRIBUTORI NON OFFRONO ALCUNA GARANZIA ADDIZIONALE, IMPLICITA O ESPLICITA, RIGUARDO IL PRODOTTO E LA SUA QUALITÀ, PRESTAZIONI, VENDIBILITÀ O APPROPRIATEZZA PER QUALSIASI USO PARTICOLARE. IN NESSUN CASO EIZO O I DISTRIBUTORI EIZO AUTORIZZATI SARANNO RESPONSABILI PER QUALSIASI DANNO ACCIDENTALE, INDIRECTO, SPECIALE, CONSEGUENTE O DI QUALSIASI ALTRA NATURA (INCLUSI, SENZA LIMITI, DANNI PER PERDITA DI PROFITTI, INTERRUZIONE DELLE ATTIVITÀ, PERDITA DI INFORMAZIONI D’AFFARI O QUALSIASI ALTRA PERDITA PECUNIARIA) DERIVANTI DALL’USO O DALL’IMPOSSIBILITÀ DI USARE IL PRODOTTO O IN QUALSIASI RELAZIONE AL PRODOTTO, SIA SU BASE DI CONTRATTO, TORTO, NEGLIGENZA, STRETTA RESPONSABILITÀ O ALTRIMENTI, ANCHE SE EIZO O I DISTRIBUTORI EIZO AUTORIZZATI SONO STATI AVVERTITI DELLA POSSIBILITÀ DI TALI DANNI. QUESTA ESCLUSIONE INCLUDE ANCHE QUALSIASI RESPONSABILITÀ CHE POSSA INSORGERE DA RECLAMI DI TERZI CONTRO L’ACQUIRENTE ORIGINALE. L’ESSENZA DI QUESTO PROVVEDIMENTO È LIMITARE LA RESPONSABILITÀ POTENZIALE DI EIZO E DEI DISTRIBUTORI DERIVANTE DA QUESTA GARANZIA LIMITATA E/O DALLE VENDITE.

BEGRÄNSAD GARANTI

EIZO NANO CORPORATION (nedan kallat "EIZO") och EIZOs auktoriserade distributörer (nedan kallade "Distributörer") garanterar i enlighet med villkoren i denna begränsade garanti (nedan kallad "Garantin") den ursprunglige köparen (nedan kallad den "Ursprunglige köparen") som köpte den i dokumentet specificerade produkten (nedan kallad "Produkten") från EIZO eller Distributörer, att EIZO eller Distributörer enligt eget gottfinnande kostnadsfritt antingen reparera eller byta ut den defekta Produkten om den Ursprunglige köparen inom Garantiperioden (definieras nedan) upptäcker att (i) Produkten fungerar felaktigt eller skadas under normal användning av Produkten i enlighet med beskrivningen i bruksanvisningen (nedan kallad "Bruksanvisning") eller att (ii) Produktens LCD-panel och ljusstyrka inte kan bibehålla den rekommenderade ljusstyrkan som anges i Bruksanvisningen under normal användning av Produkten i enlighet med beskrivningen i Bruksanvisningen.

Giltighetsperioden för denna garanti är fem (5) år från datumet för Produktens inköp (kallas här efter "Garantiperioden"). Garantin för LCD-panelen är begränsad till fem (5) år från datumet för Produktens inköp förutsatt att användningstiden är kortare eller lika med 30 000 timmar. Garantin för Produktens ljusstyrka gäller bara om Produkten har använts med den rekommenderade ljusstyrkan, som beskrivet i Bruksanvisningen och Garantiperioden för ljusstyrkan är begränsad till fem (5) år från datumet för Produktens inköp, förutsatt att användningstiden är kortare än eller lika med 30 000 timmar. EIZO och Distributörer ska inte under några villkor ha något annat ansvar än vad som anges i denna garanti gällande Produkten i relation till den Ursprunglige köparen eller tredje part.

EIZO och Distributörer kommer att upphöra med lagerhållning av Produktens delar efter sju (7) år efter att produktionen av dessa delar upphört. När skärmen repareras använder EIZO och distributörer reservdelar som uppfyller våra kvalitetsstandarder.

Garantin är endast giltig i de länder där det finns Distributörer. Garantin begränsar inte några av den Ursprunglige köparens lagstadgade rättigheter.

Oavsett andra villkor i denna garanti ska inte EIZO Distributörer under några villkor ha något ansvar i något av de fall som beskrivs nedan:

- (a) När någon bristfällighet hos Produkten kan härledas till att ha uppstått vid frakt, modifiering, ändring, felaktigt handhavande, olycka, felaktig installation, katastrof, felaktigt underhåll och/eller felaktig reparation utförd av tredje part annan än EIZO och Distributörer.
- (b) Alla former av inkompatibilitet hos Produkten på grund av möjliga tekniska innovationer och/eller bestämmelser.
- (c) Alla försämringar av sensorn;
- (d) Alla försämringar av bildens prestanda beroende på förbrukningsdelar så som LCD-panel och/eller bakgrundsbelysning etc. (t.ex. förändringar i färg, färgjämnhet, defekta pixlar inklusive fast lysande pixlar etc.).
- (e) Alla försämringar av Produkten orsakat av användning av en högre ljusstyrka än den i Bruksanvisningen rekommenderade ljusstyrkan.
- (f) Alla defekter hos Produkten som orsakats av extern utrustning.
- (g) Alla defekter hos Produkten på vilken det ursprungliga serienumret har ändrats eller avlägsnats.
- (h) All normal försämring av Produkten, speciellt förbrukningsartiklar, tillbehör och/eller yttre delar (t.ex. knappar, roterande delar, kablar, Bruksanvisningen etc.).
- (i) Varje deformation, missfärgning och/eller skevhet av Produktens yttre inklusive ytan på LCD-panelen.

För att erhålla service under denna garanti måste den Ursprunglige köparen (med hänseende till risken för skada och/eller förlust under transport) leverera Produkten till närmaste Distributör med förebetald frakt, i dess ursprungliga förpackning eller annan fullgod förpackning som ger likvärdigt skydd. Den Ursprunglige köparen måste kunna visa inköpsbevis för Produkten som klargör Produktens inköpsdatum vid begäran av garantiservice.

Garantiperioden för alla utbytta och/eller reparerade produkter under denna garanti skall upphöra vid utgången av den ursprungliga Garantiperioden.

EIZO ELLER DISTRIBUTÖRER ÄR INTE ANSVARIGA FÖR NÅGON FORM AV SKADA ELLER FÖRLUST AV DATA ELLER ANNAN INFORMATION SOM HAR LAGRATS I NÅGON FORM AV MEDIA ELLER ANNAN DEL AV NÅGON PRODUKT SOM HAR RETURNERATS TILL EIZO ELLER DISTRIBUTÖRER FÖR REPARATION.

EIZO OCH DISTRIBUTÖRERNA GARANTERAR INGET, UTTRYCKLIGEN ELLER UNDERFÖRSTÅTT, VAD BETRÄFFAR PRODUKTEN OCH DESS KVALITET, PRESTANDA, SÄLJBARHET ELLER LÄMPLIGHET FÖR NÅGON FORM AV SPECIELL ANVÄNDNING. UNDER INGA OMSTÄNDIGHETER SKALL EIZO ELLER DISTRIBUTÖRERNA HÅLLAS ANSVARIGA FÖR NÅGRA SOM HELST UNDERORDNADE, INDIREKTA, SPECIELLA, DÄRAV FÖLJANDE ELLER ÖVRIGA SKADOR (INKLUSIVE, UTAN BEGRÄNSNING TILL, SKADOR FÖR FÖRLUST AV INKOMST, AVBRUTEN AFFÄRSRÖRELSE, FÖRLUST AV AFFÄRSINFORMATION ELLER ANNAN SÄRSKILD FÖRLUST) SOM UPPSTÅTT SOM ETT RESULTAT AV ANVÄNDNING ELLER OFÖRMÅGA ATT ANVÄNDA PRODUKTEN ELLER I NÅGON FORM AV ANSLUTNING TILL PRODUKTERNA, VARE SIG DETTA GRUNDAS PÅ KONTRAKT, ÅTALBAR HANDLING, FÖRSUMLIGHET, ANSVARSSKYLDIGHET ELLER ANNAT, ÄVEN OM EIZO ELLER DISTRIBUTÖRERNA HAR INFORMERATS BETRÄFFANDE MÖJLIGHET ATT SÅDANA SKADOR FÖRELIGGER. DETTA UNDANTAG OMFATTAR ÄVEN ALL FORM AV ANSVARSSKYLDIGHET SOM KAN UPPSTÅ GENOM EN TREDJE PARTS ANSPRÅK GENTEMOT DEN URSPRUNGLIGE KÖPAREN. GRUNDBESTÅNDSDELEN I BESTÄMMELEN ÄR ATT BEGRÄNSA DET EVENTUELLA ANSVARSTAGANDET FÖR EIZO OCH DISTRIBUTÖRERNA SOM KAN UPPSTÅ GENOM DENNA BEGRÄNSADE GARANTI OCH/ELLER FÖRSÄLJNING.

有限责任保证书

EIZO NANA O 有限公司（以下简称“EIZO”）和 EIZO 授权的经销商（以下简称“经销商”），接受并依照本有限责任保证书（以下简称“保证书”）之条款，向从 EIZO 和经销商购买本文中规定产品（以下简称“产品”）的原买方（以下称“原买方”）提供保证：在保证期内（规定如下），如果原买方发现 (i) 按本产品所附使用说明书（以下简称“用户手册”）所述方式正常使用本产品过程中，本产品出现故障或损坏 或 (ii) 按用户手册所述方式正常使用本产品过程中，本产品的液晶显示屏 (LCD) 及亮度未能达到用户手册中所述的推荐亮度时，EIZO 和经销商根据其独立的判断免费修理或更换该产品。

本保证期限定为自购买本产品之日起的五（5）年（以下简称“保证期限”），但液晶显示屏（LCD）的保证期限定为使用时间在 30000 小时以下（含 30000 小时）的条件下自购买本产品之日起五（5）年的期间。仅当在用户手册中所述的推荐亮度条件下使用本产品时，才保证本产品的亮度，亮度的保证期限定为本产品的使用时间在 30000 小时以下（含 30000 小时）的条件下自购买本产品之日起五（5）年。EIZO 和经销商将不向原买方或任何第三方承担本保证书所规定之外的与本产品有关任何责任或义务。

本产品的任何部件停产七（7）年后，EIZO 和经销商将不再保留或保管任何这类部件。维修显示器时，EIZO 与经销商将使用符合我方质量控制标准的替换零件。

本保证书仅对于设有经销商的国家或地区有效。本保证书并不限定原买方的任何法律权利。

无论本保证书的任何其他条款如何规定，对于任何下列情况之一，EIZO 和经销商将不承担本保证书规定责任：

- (a) 由于运输损害、改装、改动、滥用、误用、意外事故、错误安装、灾害、维护不善和 / 或由除 EIZO 和经销商以外的第三方进行不适当的修理造成本产品的任何故障。
- (b) 由于可能发生的技术变更和 / 或调整造成本产品的任何不兼容性。
- (c) 传感器的任何劣化；
- (d) 由于诸如液晶显示屏（LCD）和 / 或背景照明等消耗品部件的老化造成的任何显示性能低劣（如色彩变化、色彩均匀性变化、烧伤像素等像素缺陷）。
- (e) 由于在比用户手册所推荐亮度更高的亮度下使用对本产品所造成的任何老化。
- (f) 因外部设备造成本产品的任何故障。
- (g) 因本产品的原序号被改变或消除造成本产品的任何故障。
- (h) 本产品的任何正常老化，尤其是消耗品、附件和 / 或附加装置（如按钮、旋转部件、电缆、用户手册等）、以及
- (i) 本产品表面包括液晶显示屏（LCD）表面的任何变形、变色和 / 翘曲。

为了获得本保证书规定的服务，原买方必须使用原包装或其他具有同等保护程度的适当包装将本产品运送到当地的经销商，并且预付运费，承担运输中的损坏和 / 或损失的风险。要求提供本保证书规定的服务时，原买方必须提交购买本产品和标明此购买日期的证明。

按本保证书规定进行了更换和 / 或修理的任何产品的保证期限，将在原保证期限结束时终止。

在返回给 EIZO 和经销商进行修理后，任何产品的任何媒体或任何部件中储存的数据或其他信息发生任何损坏或损失，对此 EIZO 和经销商将不承担责任。

对于本产品及其质量、性能、可销售性以及对于特殊用途的适合性，EIZO 和经销商不提供其他任何明示或暗示的保证。因使用本产品或无法使用本产品或因与本产品有任何关系（无论是否根据合同）而造成：任何附带的、间接的、特殊的、随之发生的或其他的损害（包括但不限于利润损失、业务中断、业务信息丢失或其他任何金钱损失）以及侵权行为、过失、严格赔偿责任或其他责任，即使已经向 EIZO 和经销商提出了发生这些损害的可能性，对此 EIZO 和经销商概不承担责任。本免责条款还包括因第三方向原买方提出索赔而可能发生的任何责任。本条款的本质是限定由于本有限责任保证书和 / 或销售本产品所发生的 EIZO 和经销商的潜在责任。

关于电子信息产品污染控制标识



本标识根据「电子信息产品污染控制管理办法」，适用于在中华人民共和国销售的电子信息产品。标识中央的数字为环保使用期限的年数。只要您遵守该产品相关的安全及使用注意事项，在自制造日起算的年限内，不会产生对环境污染或人体及财产的影响。上述标识粘贴在机器背面。

• 有毒有害物质或元素的名称及含量

部件名称	有毒有害物质或元素					
	铅 (Pb)	汞 (Hg)	镉 (Cd)	六价铬 (Cr (VI))	多溴联苯 (PBB)	多溴二苯醚 (PBDE)
印刷电路板	×	○	○	○	○	○
机箱	○	○	○	○	○	○
液晶显示器	×	×	○	○	○	○
其他	×	○	○	○	○	○

○：表示该有毒有害物质在该部件所有均质材料中的含量均在 SJ/T 11363-2006 规定的限量要求以下。
×：表示该有毒有害物质至少在该部件的某一均质材料中的含量超出 SJ/T 11363-2006 规定的限量要求。
(企业可在此处，根据实际情况对上表中打“×”的技术原因进行进一步说明)

